

UDC (07)621.7:621.8

*Jozef Varga, Rudolf Janos, Marek Sukop, Mikulas Hajduk, Peter Duchovic, Martin Bezak***MEASUREMENT OF BEAD WIRE CIRCUMFERENCE VIA OPTICAL SENSOR***Йозеф Варга, Рудольф Янош, Марек Сукоп, Мікулаш Гайдук,
Петер Духовіц, Мартін Безак***ВИМІР ОКРУЖНОСТІ БОРТОВОГО ДРОТУ ЧЕРЕЗ ОПТИЧНИЙ ДАТЧИК***Йозеф Варга, Рудольф Янош, Марек Сукоп, Мікулаш Гайдук,
Петер Духовіц, Мартін Безак***ИЗМЕРЕНИЕ ОКРУЖНОСТИ БОРТОВОЙ ПРОВОЛКИ ЧЕРЕЗ ОПТИЧЕСКИЙ ДАТЧИК**

In this article is describes how to measure the circumference of the bead wires via optical sensor, which is commonly found in optical mice. The sensors have different resolution in the range from 400 DPI to 5000 DPI. For testing was selected sensor ADNS-2610 with a resolution of 400 DPI.

Key words: bead wire, optical module, lens.

Fig.: 8. Bibl.: 6.

Описано спосіб вимірювання окружності бортових дротів за допомогою оптичного датчика, який зазвичай знаходиться в оптичних мишах. Датчики мають різний дозвіл у діапазоні від 400 до 5000 DPI. Для тестування було обрано датчик ADNS-2610 з роздільною здатністю 400 пікселів на дюйм.

Ключові слова: бортовий дріт, оптичний модуль, об'єктив.

Рис.: 8. Бібл.: 6.

Описан способ измерения окружности бортовых проволок с помощью оптического датчика, который обычно находится в оптических мышах. Датчики имеют различное разрешение в диапазоне от 400 до 5000 DPI. Для тестирования был выбран датчик ADNS-2610 с разрешением 400 пикселей на дюйм.

Ключевые слова: бортовая проволока, оптический модуль, объектив.

Рис.: 8. Библ.: 6.

Introduction. The bead component of the tire is a non-extensible composite loop that anchors the body plies and locks the tire onto the wheel assembly so that it will not slip or



Fig. 1. The bead wire and its placement

rock the rim. The tire bead component includes the steel wire loop, apex or bead filler; the chafer, which protects the wire bead components; the chipper, which protects the lower sidewall; and the flipper, which helps hold the bead in place. The bead wire loop is made from a continuous steel wire covered by rubber and wound around with several continuous loops. The bead filler is made from a very hard rubber compound, which is extruded so as to form a wedge. The bead wire loop and bead filler are assembled on a sophisticated machine.

Bead wire is an essential reinforced material for tires on automobiles, earth-moving equipment, large trucks and aircraft. The bead wire and its placement is shown on Fig. 1.

The basic elements for the construction of an optical module. The construction of the measuring optical module is based on the functional principle of optical mice, which consists from sensor, clip, led and optical lens shown in Fig. 2 [4, 6].

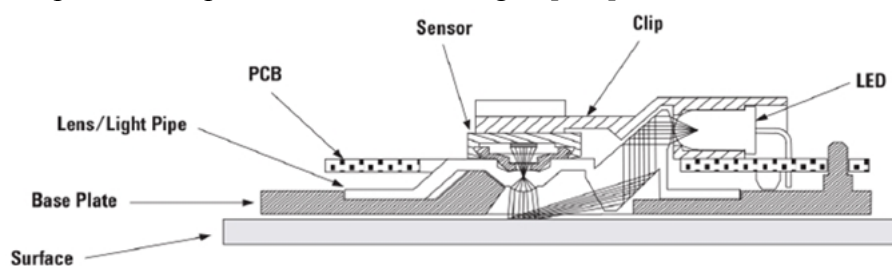

Fig. 2. Functional principle of optical mice.

For the measurement, we selected optical sensor ADNS 2610 with 400 dpi, which is powered to 5V, and a speed of sensing is up to 305 mm/s. Connection of sensor and list of components is shown in the wiring diagram Fig. 3 [4].

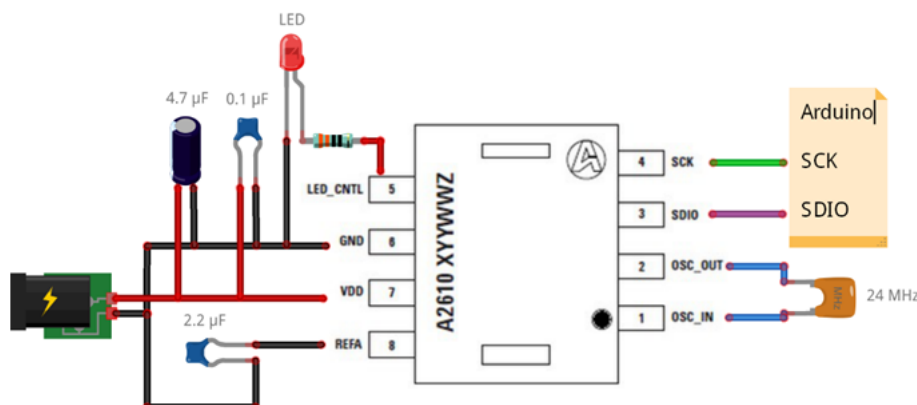

Fig. 3. Wiring diagram for sensor ADNS2610

An important part of the measuring optical module are selection and placement of optical lens that allows you to change the distance of the reference object from the image sensor inside an optical sensor Fig.4 [1, 6].

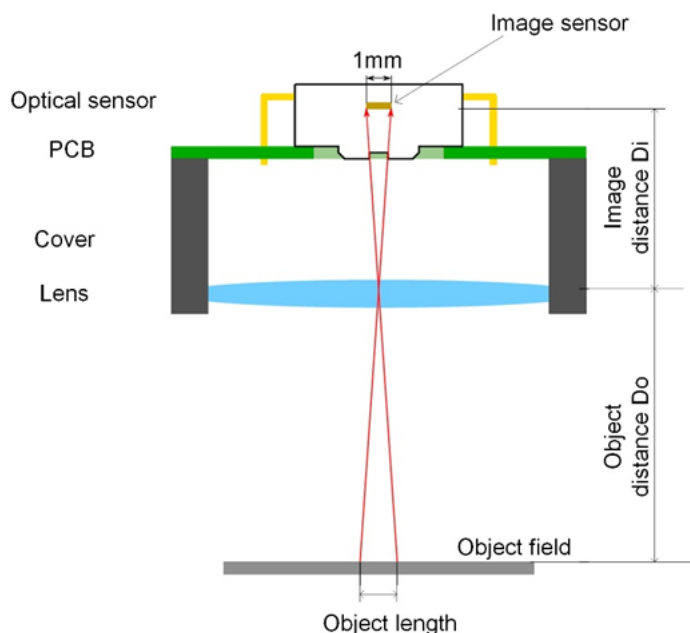

Fig. 4. Proposal of measuring optical module and main parameters

For achieving the clear and sharp image, it is necessary to determine the correct focal length of lens f [2, 3].

$$\frac{1}{f} = \frac{1}{D_o} + \frac{1}{D_i}, \tag{1}$$

where D_o is object distance and D_i is image distance.

For the selection of appropriate lens were tested three types of lenses with a focal length $f = 2.8$ mm, 3.6 mm and 4.2 mm

Image calibration of optical module. We have created optical module composed of optical sensor ADNS2610, lens and high-bright LED shown in Fig. 5. Led light is important for sufficient lighting scanned surface. In this case was selected red led, can be use blue high-bright led, too.

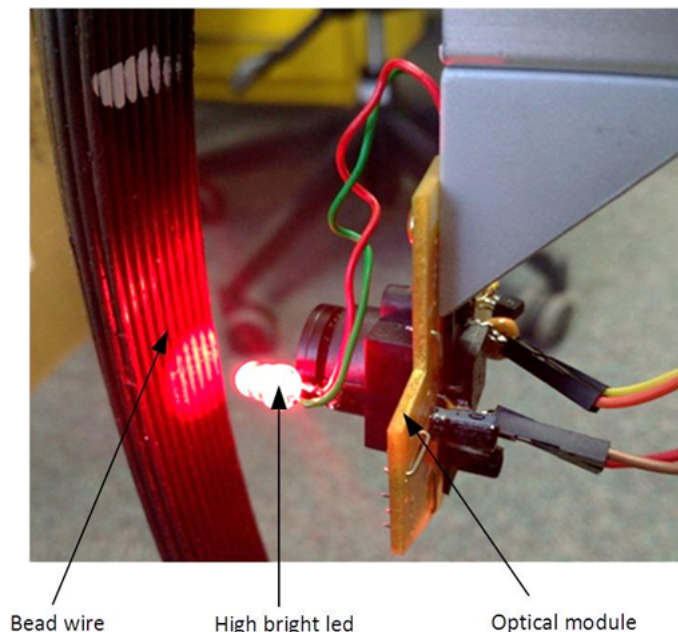

Fig. 5. Optical module

It was subsequently captured bead wire with three kinds of lens - $f = 2.8$ mm, $f = 3.6$ mm, $f = 4.2$ mm. The resulting captured images by each lens are shown and compared in the following figure 6. Lighter area in the figures shows the rope and dark shaded area represents the area between the ropes.

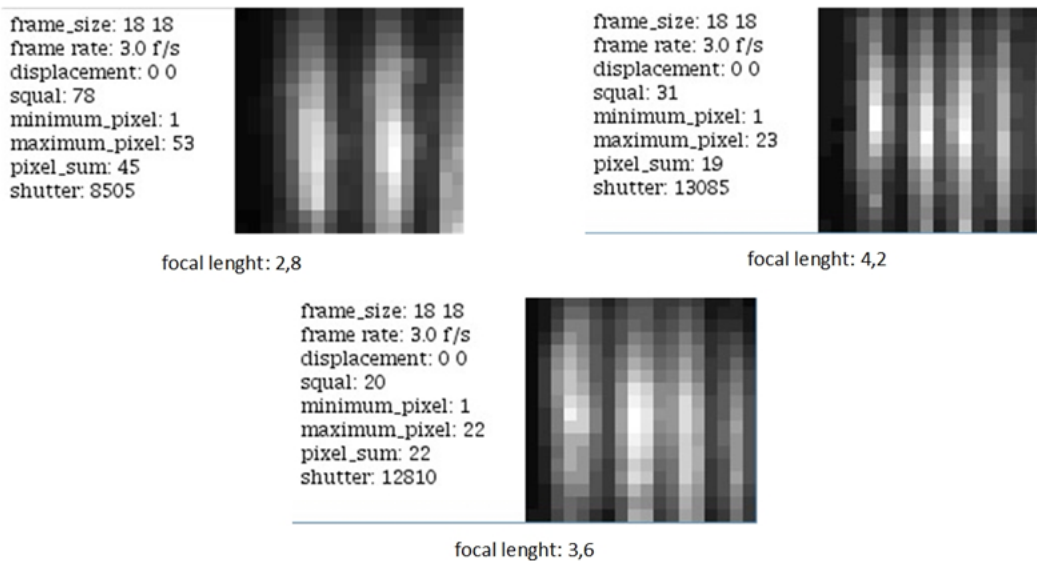

Fig. 6. Captured images by each lens

We are comparing the three images and we are recommended for measuring the circumference of the bead wires lens with a focal length $f = 2.8$ mm. With this lens captures the subject at a distance $L_p = 14$ mm and the scanning area of the leased is 7×7 mm. These values are appropriate for our measurements

The proposal of measurement circumference of bead wires via optical module. Based on proposed measuring optical module was suggests its location by measuring the inner circumference of the bead wire in the Z axis. The measurement line is always parallel to the central axis of measured bead wire. The principle of measurement is shown in figure 7. The module is rotating around the center of the swivel joint during the measurement. For detecting the track position of the module was used absolute encoder [5].

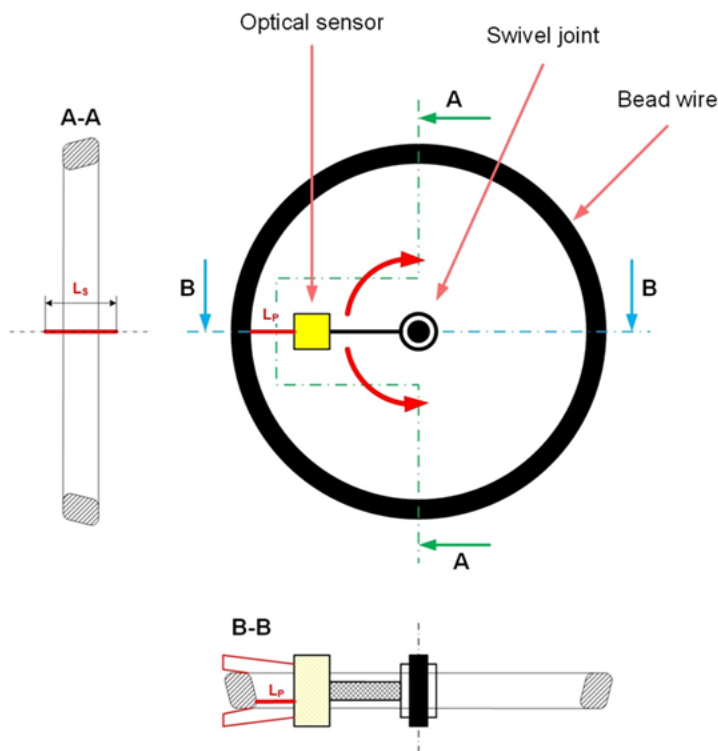

Fig. 7. Measuring principle for optical module

Following figure. 8 shows an algorithm for measuring circumference via sensor ADNS-2610. At the beginning is initializing sensor ADNS-2610, then reads the motion register in the microcontroller, in our case, we used the Arduino. When motion is detected - read the value changes in the axes X and Y . In case the motion is not detected, the sensor is in standby mode. Subsequently, the data are filtered and sent to a computer, where data are processed and evaluated.

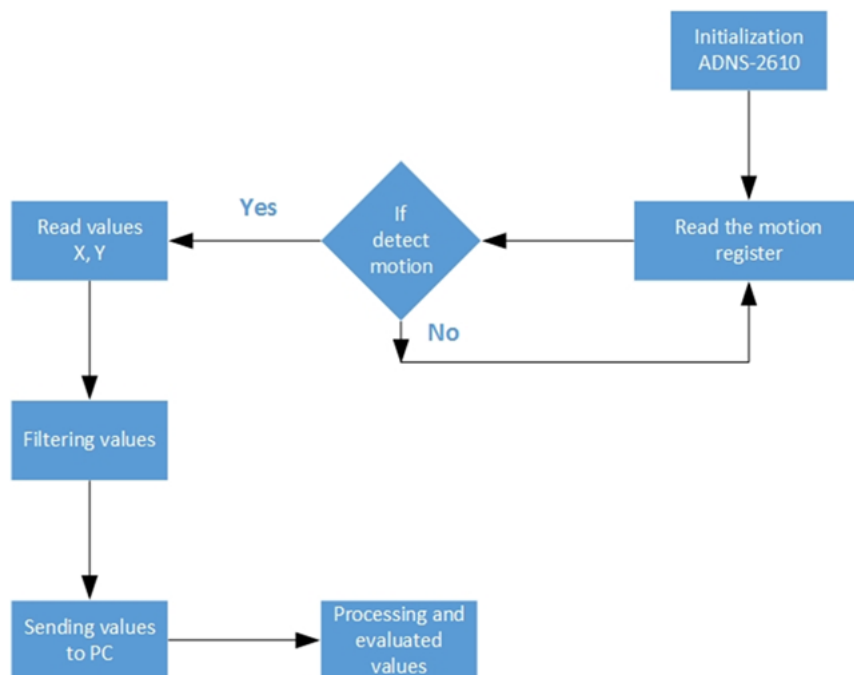

Fig. 8. Algorithm of measuring via optical module

Conclusion. The measurement principle is designed to measure the circumference of the bead wires with optical sensor ADNS-2610. After assembly the measuring stand can be tested

accuracy of module. Via visual output of the sensor will see the exact start and end of measurement in testing. In case if the measurement is not too accurate, it is possible to use an optical sensor with higher resolution and other types of lenses.

Article was created within the project research and development of Hi-Tech integrovaných strojnotechnologických systémov pre výrobu automobilových plášťov.

References

1. A. Olaru, A. Oprean, S. Olaru, D. Paune, Optimization of the neural network by using the LabVIEW instrumentation, IEEE ICMERA 2010 Proceedings, ISBN 978-1-4244-8867-4, IEEE catalog number CFP1057L-ART, pp. 40-44, 2010.
2. Zubrzycki, J., Świć, A., Taranenko, V.: Mathematical model of the hole drilling process and tyFigital automated process for designing hole drilling operations. Applied Mechanics and Materials Vol. 282 (2013), pp. 221-229.
3. P. Tuleja, E. Šidlovská, M. Hajduk: Efector Mechanism with unilateral gripping. In: TIAM - Technologiai automatyzacjamontažu. No. 1 (2013), ISSN 1230-7661, pp. 14-20.
4. <http://media.digikey.com/pdf/Data%20Sheets/Avago%20PDFs/ADNS-2610.pdf>.
5. Vince, T., Molnár, J.: Remote measurements of variable topology system, In: 1179-1180, Viedeň, Rakúsko: DAAAM International Vienna, 2011.
6. Molnár, J.: Proposal of access system based upon microcontroller, In: Electromechanical and energy saving systems: Quarterly research and production journal, Vol. 6, No. 22(2013) part 2, p. 423-426, 2013.

Jozef Varga – Eng., Ph.D, Reaserch worker, Technical university in Kosice, Faculty of Mechanical Engineering, Institute of Automatization, Mechatronics and Robotics, Department of Robotics (Komenskeho Park 8, 042 00 Kosice, Slovakia).

Йозеф Варга – Eng., Ph.D, Reaserch worker, Технічний університет Кошице, Машинобудівний факультет, Інститут технологій, мехатроніки і робототехніки, факультет робототехніки (Komenskeho Park 8, 042 00 Kosice, Slovakia).

Йозеф Варга – Eng., Ph.D, Reaserch worker, Технический университет Кошице, Машиностроительный факультет, Институт технологий, мехатроники и робототехники, факультет робототехники (Komenskeho Park 8, 042 00 Kosice, Slovakia). **E-mail:** jozef.varga.2@tuke.sk

Scopus Author ID: 56268363400

Rudolf Janos – Eng. Ph.D., Assistant Professor, Technical university in Kosice, Faculty of Mechanical Engineering, Institute of Automatization, Mechatronics and Robotics, Department of Robotics (Komenskeho Park 8, 042 00 Kosice, Slovakia).

Рудольф Янош – Eng. Ph.D., Assistant Professor, Технічний університет Кошице, Машинобудівний факультет, Інститут технологій, мехатроніки і робототехніки, факультет робототехніки (Komenskeho Park 8, 042 00 Kosice, Slovakia).

Рудольф Янош – Eng. Ph.D., Assistant Professor, Технический университет Кошице, Машиностроительный факультет, Институт технологий, мехатроники и робототехники, факультет робототехники (Komenskeho Park 8, 042 00 Kosice, Slovakia).

E-mail: rudolf.janos@tuke.sk

Scopus Author ID: 55016528600

Marek Sukop – assoc. prof., Eng. Ph.D., Associate Professor, Technical university in Kosice, Faculty of Mechanical Engineering, Institute of Automatization, Mechatronics and Robotics, Department of Robotics (Komenskeho Park 8, 042 00 Kosice, Slovakia).

Мареk Сукоп – assoc. prof., Eng. Ph.D., Associate Professor, Технічний університет Кошице, Машинобудівний факультет, Інститут технологій, мехатроніки і робототехніки, факультет робототехніки (Komenskeho Park 8, 042 00 Kosice, Slovakia).

Мареk Сукоп – assoc. prof., Eng. Ph.D., Associate Professor, Технический университет Кошице, Машиностроительный факультет, Институт технологий, мехатроники и робототехники, факультет робототехники (Komenskeho Park 8, 042 00 Kosice, Slovakia).

E-mail: marek.sukop@tuke.sk

Scopus Author ID: 36615762200

Google Scholar link: <https://scholar.google.sk/citations?user=xw4udLwAAAAJ&hl=sk>

Mikulas Hajduk – prof., Eng., PhD, Professor, Technical university in Kosice, Faculty of Mechanical Engineering, Institute of Automatization, Mechatronics and Robotics, Department of Robotics, Komenskeho Park 8, 042 00 Kosice, Slovakia.

Мікулаш Гайдук – prof., Eng., PhD, Professor, Технічний університет Кошице, Машинобудівний факультет, Інститут технологій, мехатроніки і робототехніки, факультет робототехніки (Komenskeho Park 8, 042 00 Kosice, Slovakia).

Миклаш Гайдук – prof., Eng., PhD, Professor, Технический университет Кошице, Машиностроительный факультет, Институт технологий, мехатроники и робототехники, факультет робототехники (Komenskeho Park 8, 042 00 Kosice, Slovakia).

E-mail: mikulas.hajduk@tuke.sk

Scopus Author ID: 35826618400

Duchovic Peter – Eng., Company owner, VIPO (a.s. Gen. Svobodu 1069/4, 958 01 Partizanske, Slovakia).

Петер Духовиц – Eng., Company owner, VIPO (a.s. Gen. Svobodu 1069/4, 958 01 Partizanske, Slovakia).

Петер Духовиц – Eng., Company owner, VIPO (a.s. Gen. Svobodu 1069/4, 958 01 Partizanske, Slovakia).

E-mail: duchovic@vipo.sk

Scopus Author ID: 36969733100

Bezak Martin – Eng., VIPO (a.s. Gen. Svobodu 1069/4, 958 01 Partizanske, Slovakia).

Мартін Безак – Eng., VIPO (a.s. Gen. Svobodu 1069/4, 958 01 Partizanske, Slovakia).

Мартин Безак – Eng., VIPO (a.s. Gen. Svobodu 1069/4, 958 01 Partizanske, Slovakia).

E-mail: bezak@vipo.sk