

МІНІСТЕРСТВО ОСВІТИ І НАУКИ УКРАЇНИ
ЧЕРНІГІВСЬКИЙ НАЦІОНАЛЬНИЙ ТЕХНОЛОГІЧНИЙ УНІВЕРСИТЕТ

**АНГЛІЙСЬКА МОВА
В БУДІВНИЦТВІ
ТА ЦИВІЛЬНІЙ ІНЖЕНЕРІЇ**

МЕТОДИЧНІ ВКАЗІВКИ

для самостійної роботи
студентів денної форми навчання
спеціальності 192
“Будівництво та цивільна інженерія”
II частина

Обговорено і рекомендовано
на засіданні кафедри
іноземних мов професійного спрямування
Протокол № 3 від 2 червня 2020 р.

Чернігів ЧНТУ 2020

Англійська мова в будівництві та цивільній інженерії. Методичні вказівки для самостійної роботи студентів денної форми навчання спеціальності 192 «Будівництво та цивільна інженерія» II частина / Укл. Пермінова В.А., Сікалюк А.І., Литвин С.В. – Чернігів : НУ «Чернігівська Політехніка», 2020. – 86 с.

- Укладачі:** ПЕРМІНОВА ВЛАДИСЛАВА АНАТОЛІЇВНА, кандидат педагогічних наук, доцент кафедри іноземних мов професійного спрямування
СІКАЛЮК АНЖЕЛА ІВАНІВНА, кандидат педагогічних наук, доцент кафедри іноземних мов професійного спрямування;
ЛИТВИН СВІТЛАНА ВОЛОДИМИРІВНА, завідувач кафедри іноземних мов професійного спрямування, кандидат педагогічних наук, доцент
- Відповідальна за випуск:** ЛИТВИН СВІТЛАНА ВОЛОДИМИРІВНА, завідувач кафедри іноземних мов професійного спрямування, кандидат педагогічних наук, доцент
- Рецензент:** ЛОСЬ ОЛЕНА ВІКТОРІВНА, кандидат філологічних наук, доцент, доцент кафедри іноземних мов професійного спрямування

Зміст

Передмова		4
Unit1	Major building systems.....	6
Text A	Structural system.....	10
Text B	Occupations in the construction industry.....	10
Text C	Roofs.....	12
Unit 2	Modern construction technologies.....	22
Text A	Skyscrapers.....	22
Text B	3D Printing in construction.....	31
Text C	Top 5 construction innovations	35
Unit 3	Building materials.....	40
Text A	Hand & Saw act	41
Text B	Risks.....	45
Text C	First Aid	50
Unit 4	Sustainable construction.....	58
Text A	Sustainable construction	60
Text B	Why should architects lead on a sustainable design.....	62
Text C	Environmental self-conscious design process	64
Text D	Eco Cycles.....	68
Supplementary reading		75
References		85

Передмова

Методичні вказівки для самостійної роботи студентів денної форми навчання напряму підготовки 192 «Будівництво та цивільна інженерія» призначені для аудиторної та самостійної роботи студентів.

Метою методичних вказівок є підготовка студентів до застосування англійської мови в професійній сфері, що досягається за допомогою відповідних текстових і відеоматеріалів зі спеціально розробленою методикою. При цьому використовуються аутентичні матеріали і вправи, спрямовані на роботу над усіма видами мовленнєвої діяльності (читання, письмо, аудіювання і говоріння) в об'єктивних сучасних навчальних програмах з англійської мови для немовних вищих закладів освіти.

Методичні вказівки також містять додаток з читання з аутентичними текстами з тем, які вивчаються в основних розробках. В розділі представлені додаткові тексти без завдань, які можуть бути використані як для роботи в групі, так і для самостійної роботи студентів. Вони або розширюють інформацію з будівництва, або представляють нові проблеми в області будівництва.

Тексти, відео-фрагменти і візуальні матеріали методичних вказівок запозичені з сучасних журналів, довідників, інтернет-ресурсів з будівництва і спрямованості на відтворення типових ситуацій. Тексти актуальні, відповідають сучасним реаліям будівництва, що викликає і підтримує інтерес майбутніх спеціалістів.

Кожен розділ містить кілька тестів до текстів з системою попередніх і наступних вправ, задачі на укріплення вивченої лексики за спеціальностями, груповими творчими завданнями для розвитку навичок, відео-фрагментів і практик розвитку навичок аудиту і задач для активізації провідного матеріалу в письмовій формі.

Інтерактивні задачі, націлені на обговорення проблематики текстів, забезпечують розвиток комунікативної компетенції, необхідної в сучасних умовах, а також дозволяють студентам навчитися висловлювати думки англійською мовою, розуміти проблеми, давати аргументовану відповідь при аналізі інформації.

Лексичні вправи спрямовані на ознайомлення студентів з професійною лексикою. Активна лексика відбиває найважливіші поняття і явища, представлені в літературі зі спеціальності. Термінологічна лексика закріплена в різноманітних завданнях, які подані за принципом «від простого до складного» - від рівня слова, словосполучення, речення до рівня надфразової єдності.

Відео-сюжети монологічного і діалогічного характеру з мережі Інтернет безпосередньо пов'язані з темою занять. Контроль розуміння здійснюється за допомогою запитань-відповідей, шляхом заповнення таблиць / схем та ін. Мета завдань полягає в розумінні загального розуміння прослуховування тексту, наближення або виведення конкретної інформації, яка є основою для короткого викладу аудіотекста, дискусії по темі.

Методичні вказівки підготовлені з метою підготовки фахівців, здатних представити проекти англійською мовою на міжнародних конференціях, брати участь в дискусіях з професійної тематики, налагоджувати міжнародні зв'язки з іноземними партнерами.

Переважає частина методичних вказівок має формат міжнародних іспитів (FCE, CAE, IELTS), що дозволить студентам навчитися виконувати типові екзаменаційні завдання вже на базових заняттях з англійської мови у ВНЗ. Це відіграє певну роль при підготовці студентів до іспитів міжнародного формату, які користуються великим попитом в наш час.

UNIT 1

MAJOR BUILDING SYSTEMS

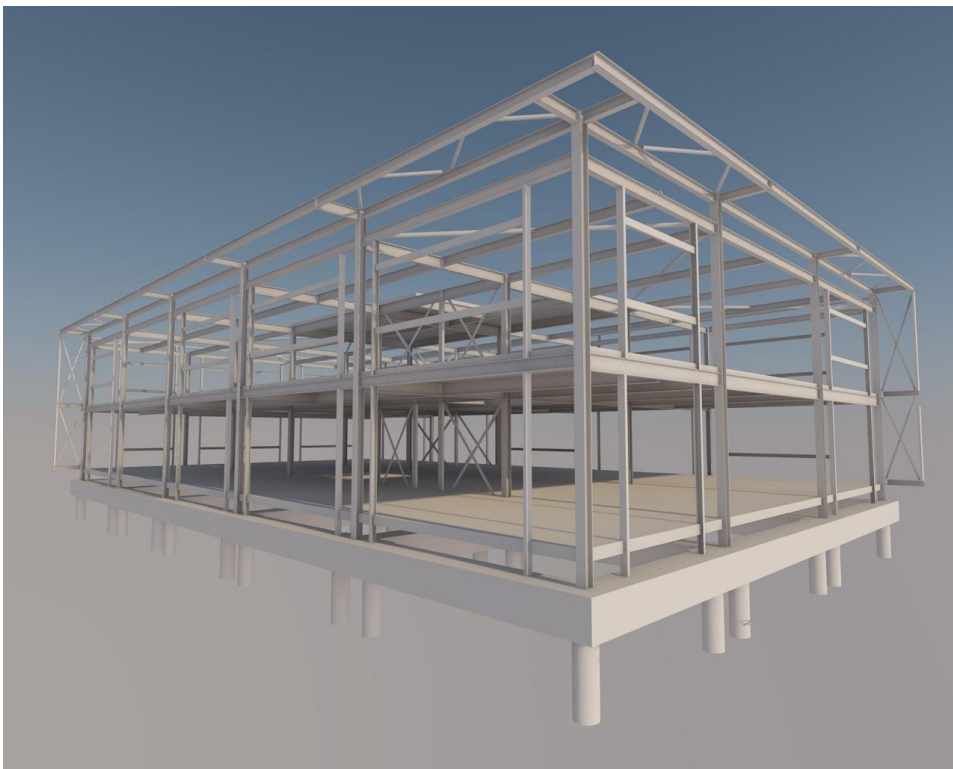

Exercise 1. Complete the paragraph with a word or phrase from the box.

subsystems	ground	walls	structural deck
HVAC	floor	load	

The simplest building system consists of only two components. One component is a (1) ... – a flat, horizontal surface on which human activities can take place. The other component is an enclosure that extends over the floor and also around it to provide shelter from the weather. The (2) ... may serve as the floor in primitive buildings. In better buildings, however, the floor may be a (3) ... laid on the ground or supported above ground on structural members, such as the joist and walls in Fig. 19. The (4) ... are seated on foundations in the ground. Additionally, footings are required at the base of the foundations to spread the (5) ... over a large area of the ground, to prevent the building from sinking (Fig. 21). More advanced buildings consist of different (6) ... which include structural framing, plumbing, lighting, acoustics, safety systems, electric power systems, and (7) ... (heating, ventilation, and air conditioning).

Exercise 2. Look at the components of a building in Figure 19 and match them with their descriptions.

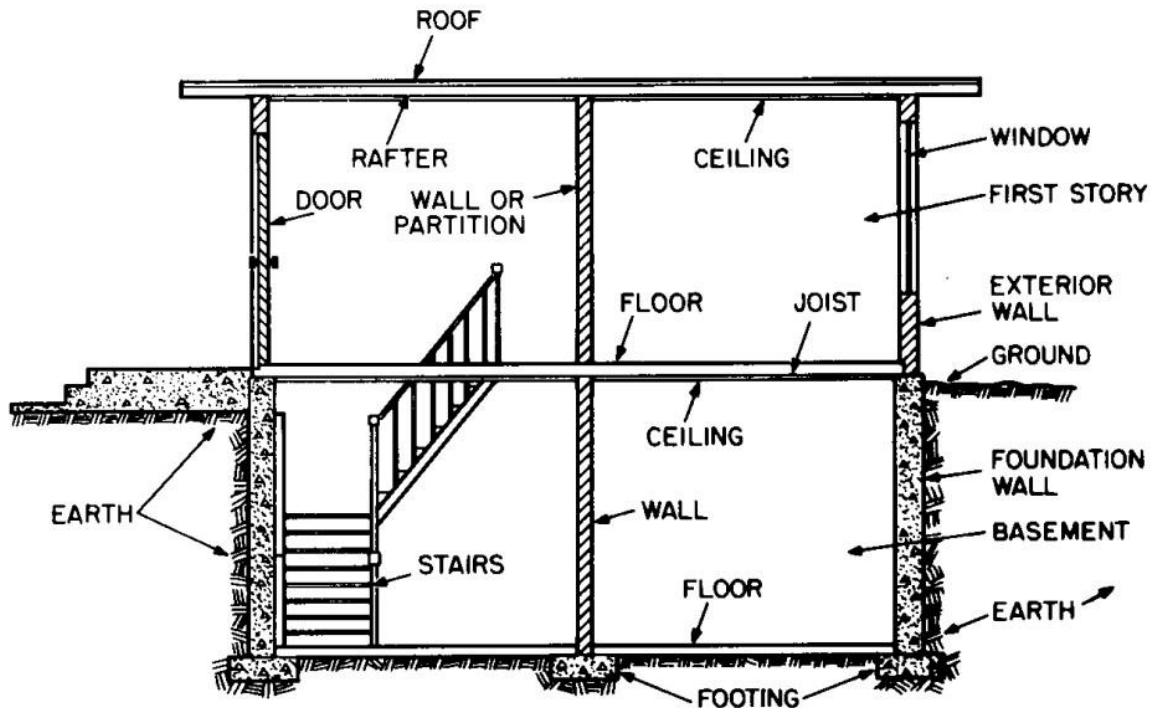

Fig. 19. Location of Some Major Components

- I. 1. The substructure.
- 2. The superstructure.

A. The part of a building below ground level. It includes footings, the basement and the foundation walls.

B. The part of a building above ground level. It includes the walls, floors, roofs, beams and columns.

II.

- | | |
|-----------------|-------------|
| 1. Foundations. | 7. Roof. |
| 2. Footings | 8. Stairs. |
| 3. Basement | 9. Window. |
| 4. Walls. | 10. Doors. |
| 5. Floor. | 11. Joist |
| 6. Ceiling | 12. Rafters |

A. It is a succession of steps connecting two spaces located at different levels. They may be of wood, stone, reinforced concrete or metal.

B. The surface at the top of a room.

C. It is the lowest part of the structure. It is usually made of monolithic concrete, concrete blocks, piles or bricks. It keeps the floors from contact with the soil.

D. They are constructed in walls to allow access.

E. Long pieces of wood that support a roof.

F. They enclose internal spaces and support the weight of the floors and roof. They also protect the interior from exposure to the weather. They are made of wood, bricks, stone, concrete.

G. A flat, horizontal surface on which human activities can take place. It divides a building into storeys. At present it can be finished in wood or linoleum.

H. A story of a building partly or entirely underground.

I. It is the topmost part of a building. It covers the building and protects it from exposure to the weather. It must be well framed, sustain snow loads and serve as insulation to prevent heat transmission.

J. It is an opening in the wall of a structure which lets the light and air.

K. They are required at the base of the foundations to spread the load over a large area of the ground, to prevent the building from sinking.

L. A strong, heavy board that supports a floor or ceiling.

Text A

Exercise 3. Match the words with their meanings. The definitions will help you.

прогін (даху)	ферма	балка настилу	косоур
ригель	кроквяна балка	головна балка	

Joists are closely spaced to carry light loads.

Stringers support stairs.

Purlins are placed horizontally to carry roof decks.

Rafters are placed on an incline to carry sloping roof decks.

Girts are light horizontal members that span between columns to support walls.

Girders may be heavily loaded beams or horizontal members that support other beams.

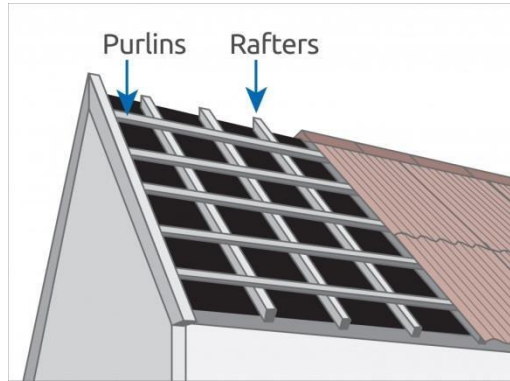

Fig.20. Roof Components

Trusses serve the same purposes as girders but consist of slender horizontal, vertical, and inclined components with large open spaces between them. The spaces are triangular in shape.

Exercise 4. Match the pictures (a, b, c) with the headings below. Then read the text and check your answers.

(...) foundation wall on continuous footing;

(...) pile footing for a column;

(...) individual spread footing for a column.

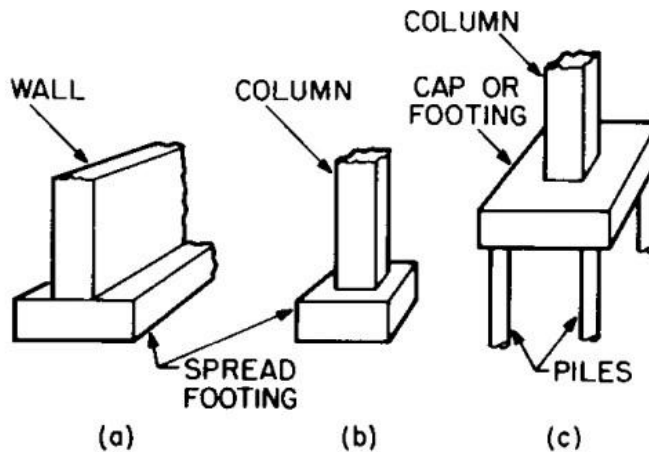

Fig. 21. Foundations

STRUCTURAL SYSTEM

The part of a building that extends above the ground level outside is called the **superstructure**. The part below the outside ground level is called the **substructure**. The parts of the substructure that distribute building loads to the ground are known as **foundations**.

Foundations may take the form of walls. When the ground under the building is excavated for the basement, the foundation walls have the additional task of retaining the earth along the outside of the building (Fig. 19). The superstructure in such cases is erected atop the foundation walls.

The footing under a wall (Fig. 21a) is called a **continuous spread footing**. A slender structural member, such as a column (Fig. 21b), is seated on an **individual spread footing**. When the soil is so weak that the spread footings for columns become very large, it is often economical to combine the footings into a single footing under the whole building. Such a footing is called a **raft** or a **floating foundation**. For very weak soils, it is necessary to use the foundations on **piles** (Fig. 21c).

In most buildings the superstructure consists of floor and roof decks, horizontal members that support them, and vertical members that support the other components.

The horizontal members are generally known as **beams**, but they are also called by different names in specific applications. For example: **joists, stringers, purlins, rafters, girts, girders, trusses**.

Floor and roof decks or the beams that support them are usually seated on **load-bearing walls** or carried by columns, which carry the load downward. The system comprising decks, beams, and bearing walls is known as **load-bearing construction**. The system composed of decks, beams, and columns is known as **skeleton framing**.

Both types of systems must be designed to transmit vertical (gravity) loads to the foundations. Vertical walls and columns are appropriate for carrying vertical loads downward. But acting alone, these structural members are inadequate for resisting lateral forces.

One way to provide lateral stability is to incorporate in the system diagonal members, called **bracing**. Bracing, columns and beams work together to carry the lateral loads downward. Another way is to connect beams to columns to prevent a change in the angle between the beams and columns, thus making them work together as a rigid frame to resist lateral movement. Still another way is to provide long walls, known as **shear walls**, in two perpendicular directions. The walls then act like vertical beams (**cantilevers**) in transmitting the forces to the foundations.

Exercise 5. Answer the questions.

1. What are the main structural components of a building?
2. What is the superstructure?
3. What is the substructure?
4. The parts of the superstructure that distribute building loads to the ground are known as foundations, aren't they?
5. What types of footing do you know?
6. Beams are called by different names in specific applications, aren't they?

7. How do you call the system comprising decks, beams, and bearing walls?
8. How do you call the system comprising decks, beams, and columns?
9. Can vertical walls and columns provide lateral stability without bracing?
10. Can shear walls provide lateral stability?

Exercise 6. Match the beginning of the sentence to its ending.

1. The footing under a wall is called...
2. For very weak soils, it is necessary to use...
3. Floor and roof decks or the beams that support them are usually seated on...
4. One way to provide lateral stability is to...
5. Shear walls act like...

- A. the foundations on piles.
 B. vertical beams (cantilevers) in transmitting the forces to the foundations.
 C. incorporate in the system diagonal members, called bracing.
 D. a continuous spread footing.
 E. load-bearing walls.

Exercise 7. Complete the table.

PART OF A BUILDING	FUNCTION
(1) ...	This part of the substructure distributes building loads to the ground.
(2) ...	It is used for very weak soils.
Load-bearing construction and skeleton framing	(3) ...
Bracing	(4) ...
(5) ...	They transmit the forces to the foundations acting like vertical beams (cantilevers).

Exercise 8. What is in the picture? Use text A to help you. The terms are given in bold.



1. _____

2. _____

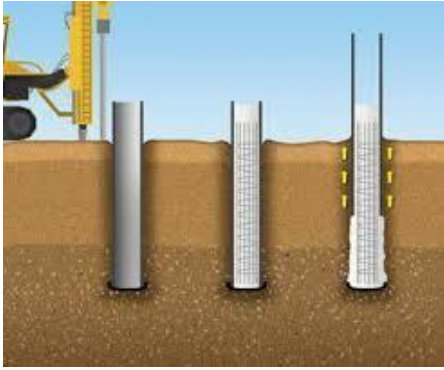

3. _____

4. _____

Exercise 9. Watch video 4.1 and answer the questions. Translate the words in *italics* before listening.

RAISED OR SOLID BUILDING FOUNDATIONS:

<https://www.youtube.com/watch?v=AaJnlwvmW8>

slope *concrete slab* *soil* *plumbing* *pipe adjustments*
water leak *crack* *to eliminate*

1. What kind of foundations is it better to choose for a house on the slope?
2. What kind of foundations does the presenter prefer in general? Why?
3. Is a solid concrete foundation stronger than a wood floor raised foundation?
4. Is it easier to make repairs and remodeling to your house with a raised floor foundation or a solid concrete foundation?

Text B

Exercise 10. Match the words with their meanings.

1. Shape.	A. Куполоподібний дах.
2. Attic space.	B. Похила площина.
3. Requirements.	C. Фронтон даху.
4. Curved surface.	D. Вимоги.
5. Plane surface.	E. Звис даху.
6. Pitch.	F. Схожий.
7. Sloped roof.	G. Арковий дах.
8. Inclined planes.	H. Форма.
9. Similar.	I. Конє к даху.
10. Underneath.	J. Люкарна (віконний отвір в схилі даху).

11. Glazed opening.	К. Нахил.
12. Skylight.	Л. Під поверхнею чого-небудь.
13. Dormer.	М. Ребро даху.
14. Hip.	Н. Криволінійна поверхня.
15. Arched roof.	О. Плоска поверхня.
16. Dome roof.	Р. Мансардний простір.
17. Sawtooth roof.	Q. Засклений отвір.
18. Ridge.	Р. Світловий люк.
19. Gable.	S. Скатний дах.
20. Eaves.	Т. Пилкоподібний дах.

Exercise 11. Choose the best alternative. Then read the text and check your answers.

1. Roofs may have any of a wide variety of *figures / shapes*.
2. Roofs are sometimes given *circular / curved* surfaces.
3. A flat roof has a slight *pitch / hole* for drainage purposes.
4. A pitched roof is formed by a combination of two *flat / inclined* planes.
5. Some roofs may have *skylights / gables* for daylighting the building interior.
6. Roofs are often used to enclose *attic / basement* space.
7. Windows may be set in *dormers / hips*.



Fig. 22. Dormers

ROOFS

Roofs may have any of a wide variety of shapes. A specific shape may be selected because of appearance, need for attic space under the roof, requirements for height between roof and floor below, structural economy, or requirements for drainage of rainwater and shedding of snow. While roofs are sometimes given curved surfaces, more often roofs are composed of one or more plane surfaces. Some commonly used types are shown in Fig. 23.

A **flat roof** shown in Fig. 23a is nearly horizontal but has a slight pitch for drainage purposes. A more sloped roof is called a **shed roof** (Fig. 23b). A **pitched roof** (Fig. 23c) is formed by a combination of two inclined planes. Four inclined planes may be combined to form either a **hipped roof** (Fig. 23d) or a **gambrel roof** (Fig. 23e). A **mansard roof** (Fig. 23f) is similar to a hipped roof but, composed of additional planes, encloses a larger volume underneath.

Any of the roofs above may have glazed openings, called skylights (Fig. 23b), for daylighting the building interior. The roofs shown in Fig. 23c-f are often used to enclose attic space. Windows may be set in dormers that project from a sloped roof (Fig. 23c). Other alternatives, often used to provide large areas free of walls or columns, include arched or dome roofs.

Monitored roofs are sometimes used for daylighting and ventilating the interior. A monitor is a row of windows installed vertically above a roof (Fig. 23g). Figure 23h illustrates a variant of a monitored roof that is called a sawtooth roof.

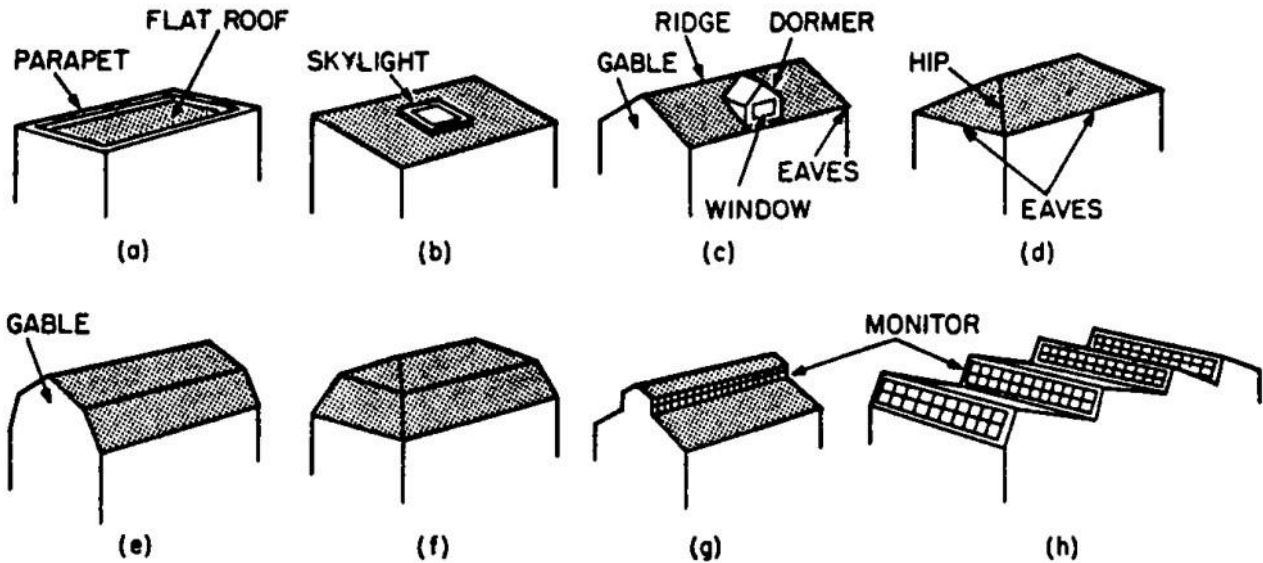

Fig. 23. Types of Roofs

Exercise 12. Match each description to the term it describes.

- Flat roof Hipped roof
- Shed roof Mansard roof
- Pitched roof Monitored roof

1. It is formed by a combination of four inclined planes.
2. It is nearly horizontal but has a slight pitch for drainage purposes.
3. It has a row of windows installed vertically above a roof.
4. It is a more sloped roof than a flat roof.
5. It is formed by a combination of two inclined planes.
6. It is similar to a hipped roof but, composed of additional planes, encloses a larger volume underneath.

Exercise 13. Is it True or False?

1. A specific shape of a roof is not selected because of structural economy.
2. More often roofs are composed of one or more plane surfaces.
3. A flat roof is formed by a combination of two inclined planes.
4. A hipped roof is similar to a gambrel roof.
5. Mansard roofs never have skylights.
6. Monitored roofs are sometimes used for daylighting and ventilating the interior.
7. A monitor is a row of windows installed vertically under a roof.

Exercise 14. Complete the dialogue using the words from the box. Then role play this dialogue. You can make some changes if you wish.

discuss	attic	speaking	similar
roof	headroom	benefit	help

Architect: Glenn Associates, this is Rhonda (1)

Homeowner: Hello Rhonda, this is Brad Creighton. We spoke last week about you possibly designing my house.

Architect: Ah yes. How may I (2) ... you today?

Homeowner: I was thinking about the roof. I'd like to (3) ... some options.

Architect: Certainly. There are several options. For example, with a gambrel (4) ... , you get a symmetrical roof with two different slopes on each side.

Homeowner: Interesting. What's the (5) ... of that design?

Architect: It drains water well but also gives you a lot of (6) ... on the top floor.

Homeowner: I see. What are some other designs?

Architect: There's also a mansard roof. It's (7) ... to a gambrel, but the ends are hipped at the corners. **Homeowner:** What does that mean, exactly?

Architect: The slopes come together. A gambrel roof has vertical gables on the ends instead.

Homeowner: Ah, I understand. Is there an advantage to the mansard design?

Architect: It makes the most use of the (8) ... and often looks more decorative.

Exercise 15. Work in pairs. Look at the house in Figure 24. Then cover it with a sheet of paper and answer the questions without looking.



Fig. 24. Seaside Cottage

1. Where is the house located?
2. How many floors are there in the house?
3. What type of roof does the house have?
4. Does it have any skylights?
5. How many dormers are there?
6. Does the house have a monitored roof?
7. Is there a chimney in the roof?
8. Have you seen the gable in the picture?
9. Do the rooms have a view of the countryside?
10. The house is in bad condition, isn't it?

Exercise 16. Watch video 4.2. What is the correct order of the items in the video?

ROOF STRUCTURE SUMMARY

<https://www.youtube.com/watch?v=n0CrtpuWL4w>

- Truss
- Purlins
- Rafters
- Truss Rafter Roof

Text C

Exercise 17. Which word is the odd one? Why?

- a. Walls, roof, heat, foundations, windows.
- b. Strong, durable, water-resistant, mortar, fire-resistant.
- c. Facing, sheathing, ridge, insulation.
- d. Masonry, panels, framing, load.
- e. Bricks, beams, concrete blocks, glass blocks, clay tiles.

Exercise 18. Write 3 sentences with the words from exercise 17. Use as many terms as possible in each sentence.

Example: Facing should be strong, durable and water-resistant.

Exercise 19. Figure 25 shows some elements of different types of walls. Translate them into Ukrainian.

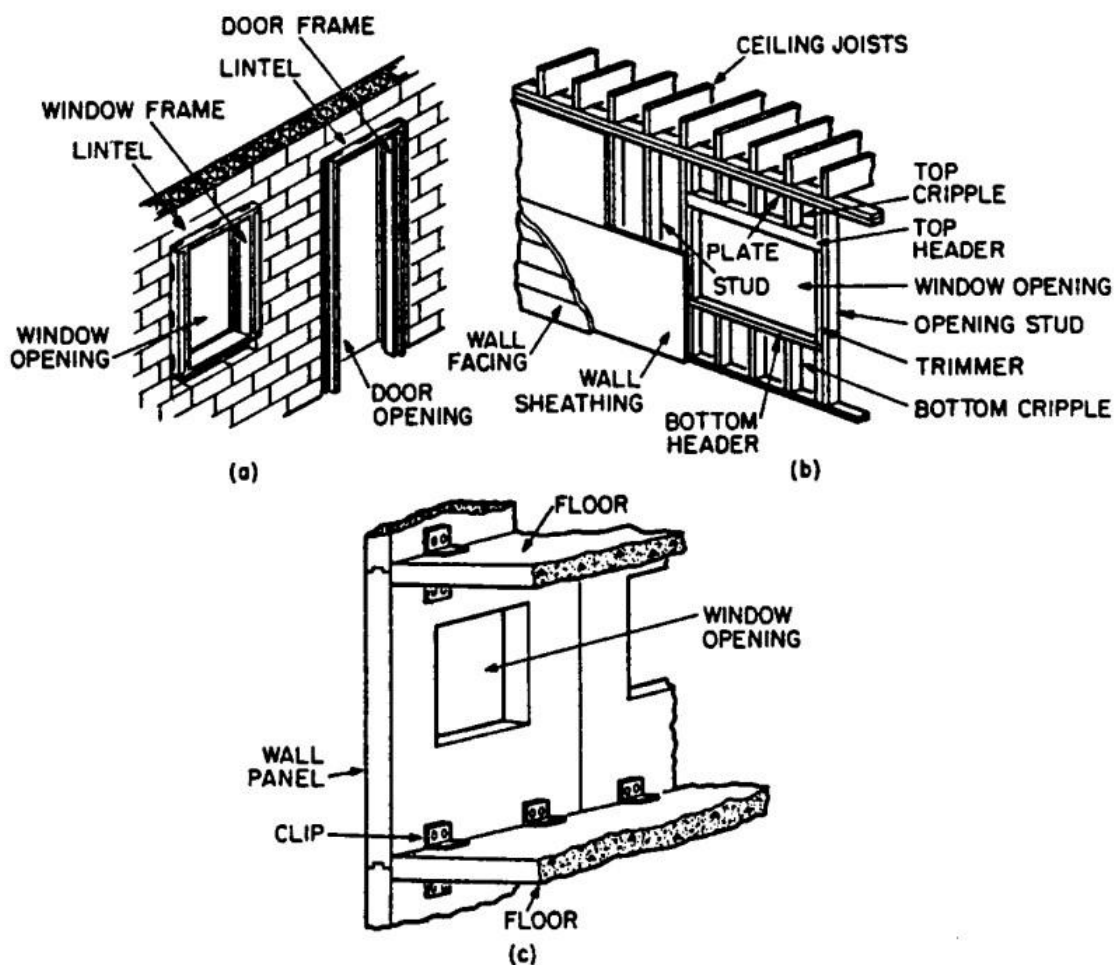

Fig. 25. Types of exterior wall construction:
 (a) concrete-block wall; (b) wood-framed wall; (c) precast-concrete curtain wall

Exercise 20. Read and translate the text.

WALLS

Exterior walls enclose a building below the roof. The basic element in the walls is a strong, durable, water-resistant facing. For added strength or lateral stability, this facing may be supplemented on the inner side by **sheathing** (Fig. 25b). A layer of insulation should be incorporated in walls to resist passage of heat.

Generally, walls may be built of masonry, panels, framing or a combination of these materials.

Masonry consists of small units, such as bricks, concrete blocks, glass blocks or clay tiles, held together by mortar. Figure 25a shows a wall built of concrete blocks.

Panel walls consist of much larger units. Made of metal, concrete, glass, plastics or preassembled bricks, a panel may extend from foundations to the roof in single-story buildings, or from floor to floor in multistory buildings. Large panels may have one or more windows. Figure 25c shows a concrete panel with a window.

Framed walls consist of slender, vertical, closely spaced structural members, tied together with horizontal members at top and bottom, and interior and exterior facings. Thermal insulation may be placed between the components. Figure 4b shows a wood-framed exterior wall.

Combination walls are constructed of several different materials. Metal, brick, concrete or clay tile may be used as the exterior facing because of strength, durability, and water and fire resistance. However, these materials are rather expensive. The exterior facing can be backed up with a less expensive material. For example, brick may be used as an exterior facing with wood framing or concrete blocks.

Exterior walls may be classified as curtain walls or bearing walls. **Curtain walls** serve mainly as an enclosure. Supported by the structural system, such walls need to be strong enough to carry only their own weight and wind pressure on the exterior face. **Bearing walls**, in contrast, serve not only as an enclosure but also to transmit to the foundation loads from other building components, such as beams, floors, roofs and other walls.

Openings are provided in exterior walls for a variety of purposes, but mainly for windows and doors. Structural support must be provided over openings to carry the weight of the wall above. Usually, a beam called a lintel is placed over openings in masonry walls (Fig. 25a) and a beam called a top header is set over openings in wood-framed walls.

Exercise 21. Match each description to the term it describes.

- Panel walls
- Framed walls
- Combination walls
- Curtain walls
- Bearing walls

1. They serve mainly as an enclosure. Supported by the structural system, such walls need to be strong enough to carry only their own weight and wind pressure on the exterior face.
2. They are constructed of several different materials. Metal, brick, concrete or clay tile may be used as the exterior facing, which can be backed up with a less expensive material, such as wood.
3. They are made of metal, concrete, glass, plastics or preassembled bricks. A panel may extend from foundations to the roof in single-story buildings, or from floor to floor in multistory buildings.
4. They consist of slender, vertical, closely spaced structural members, tied together with horizontal members at top and bottom, and interior and exterior facings.
5. They serve not only as an enclosure but also to transmit to the foundation loads from other building components, such as beams, floors, roofs and other walls.

Exercise 22. Choose the best answer.

1. The purpose of the article is to ... A.
Describe materials and finishes.
B. Show how to construct a wall.
C. Present different types of wall construction.
2. What is the basic element in exterior walls? A.
Sheathing.
B. Facing.
C. Mortar.

3. What should be done to resist passage of heat? A.
Insulation should be incorporated in walls.
B. Facing should be supplemented on the inner side by sheathing.
C. Concrete blocks should be held together by mortar.
4. In multistory buildings a panel extends from floor to floor. A.
Yes.
B. No.
5. The exterior facing in combination walls can be backed up with a less expensive material, such as...
A. Brick.
B. Metal.
C. Wood framing or concrete blocks.
6. What is the function of curtain walls?
A. To carry only their own weight and wind pressure on the exterior face.
B. To transmit to the foundation loads from other building components.
C. To provide water and fire resistance.
7. How do you call the beam placed over openings in masonry walls? A.
Top header.
B. Lintel.
C. Joist.

Exercise 23. Match the words to make phrases. Text C will help you.

- | | |
|----------------------|----------------|
| 1) curtain; | a) resistance; |
| 2) water; | b) tile; |
| 3) lateral; | c) insulation; |
| 4) concrete; | d) stability; |
| 5) clay; | e) wall; |
| 6) preassembled; | f) pressure; |
| 7) single-story; | g) block; |
| 8) thermal; 9) wind; | h) building |
| 10) wood. | i) bricks; |
| | j) framing. |

Exercise 24. Work in pairs. Close the books. Take turns in describing different types of walls. Your partner has to guess what type of wall construction you are talking about.

Exercise 25. Watch video 4.3 and answer the question: How can you identify if a wall is load bearing or not?

HOW TO IDENTIFY IF A WALL IS LOAD BEARING OR NOT
https://www.youtube.com/watch?v=nJSsRVoy_U0

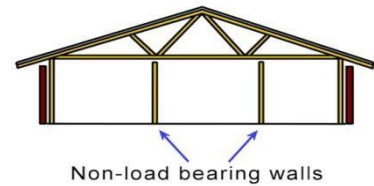

Exercise 26. Here are some components of buildings, but the letters are jumbled. What are they? Use texts A, B, C to help you.

loofr	foor	farter	jotis	gooftin
snoudfation	srust	lipe	crabing	rodrem
lightysk	bagle	cafig lapen	theashing	

Exercise 27. Work in pairs. Use one piece of paper for all pictures. Draw a component of a building. Your partner has to write how it is called. Then your partner has to do the same. And now it is your turn to write what it is. Take turns doing this activity for 3 minutes. When your teacher says "stop", hand in your pictures. The winners will have the largest number of pictures with correct titles.

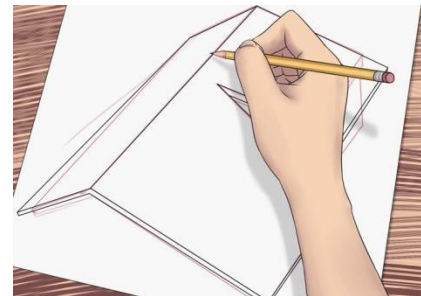

Exercise 28. Work in pairs. Put the sentences in a logical sequence.

1. They built the walls.
2. They cleared the ground.
3. They laid the drains.
4. They put in the electrics.
5. They plastered the walls inside.
6. They dug foundations trenches.
7. They poured cement into the trenches.
8. They put up the rafters.
9. They tiled the roof.
10. They painted the inside walls.
11. They put in the plumbing.
12. They agreed the plans with the client.
13. They laid grass round the new house.

Exercise 29. Work in small groups. Imagine you are going to build a hotel. In your group discuss:

1. What kind of building are you going to have (a single-story or multistory building)?
2. What kind of foundations will you choose for your building? Why?
3. How will you provide lateral stability?
4. What type of roof do you prefer? Why?
5. What kind of walls will your building have? What materials will you use?

Then compare your ideas with the rest of the class. Your teacher or one of your groupmates may act as a hotel holder who has to choose the best option.

UNIT 2 MODERN CONSTRUCTION TECHNOLOGIES

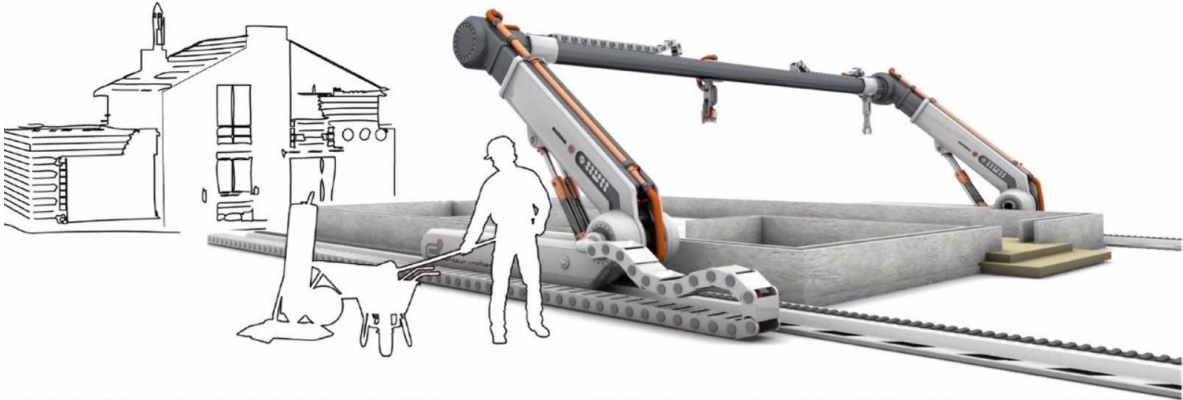

Exercise 1. Read extracts A-E about modern construction technologies and techniques and match them to the pictures 1-5.

- A. The construction workers of the future could be robots. The Harvard School of Engineering and Applied Sciences designed termite-inspired bots which can perform construction tasks.
- B. Italian engineer Enrico Dini said: “We might print not only buildings, but entire urban sections.” This may be true, with architects already producing the first 3D-printed houses.
- C. Malama Composites has started producing foam material from plant materials like hemp, kelp and bamboo which will be used in insulation and furniture. The foam can provide high resistance to heat and give protection against molds and pests.
- D. In Indonesia, Owings & Mills has shown its design for a 99-story Pertamina Skyscraper that is shaped like flowers petals. What’s interesting to note here is that to harness wind energy, the skyscraper will slightly open its peak to allow its wind funnel to convert high speed winds into energy sources.
- E. To decrease construction costs and to reduce waste, VS-A and Chartier-Corbasson presented their skyscraper design made from trash. The Organic London Skyscraper will have panels made out

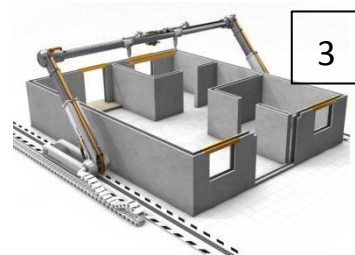

of plastic waste and discarded paper.

Exercise 2. Write the technologies these inventors have developed.

1. Owings & Mills.
2. Malama Composites.
3. VS-A and Chartier-Corbasson.

4. The Harvard School of Engineering and Applied Sciences.

Exercise 3. Discuss in small groups.

1. What is the most useful invention (choose from A-E in ex.1)? Why?
2. Do you know any other modern technologies in construction? What are they?
3. Do you agree that skyscrapers will play a vital role in the coming decades?

Text A

Exercise 4. Match the words with their definitions.

- | | |
|---------------------------------|---|
| 1. To bolt | A. How high something is. |
| 2. To complete | B. A set of stairs between one floor and the next. |
| 3. To damage | C. How heavy something is. |
| 4. Currently | D. To move from one side to another. |
| 5. To swing | E. Very thin piece of metal that is used to transport electricity. |
| 6. Wire | F. At the moment, now. |
| 7. To dig (- dug, - dug) | G. Machine that takes people from one floor to another. |
| 8. Solid | H. To nail two things together. |
| 9. Elevator | I. System for making a building or a room warm. |
| 10. Weight | J. To put. |
| 11. Flight of stairs | K. To finish. |
| 12. Heating | L. To make weaker. |
| 13. Height | M. Very hard. |
| 14. To lay (-laid, -laid) | N. To go up. |
| 15. Landmark | O. To put something up. |
| 16. To rise (-rose, -risen) | P. Something that is easy to see and that helps you know where you are. |
| 17. To raise (-raised, -raised) | Q. To make a hole in the earth. |

Exercise 5. Read the text and match each part of the text (A-D) with the correct heading (1-4).

1. History of Skyscrapers
2. Building Techniques
3. Service Areas
4. To Be the Tallest One

SKYSCRAPERS

A skyscraper is a tall building higher than 50 m. One common feature of skyscrapers is a steel framework that supports curtain walls. Some early skyscrapers have a steel frame that enables the construction of load-bearing walls taller than of those made of reinforced concrete. The walls of modern skyscrapers are not load-bearing and most skyscrapers are characterized by large areas of windows made possible by the steel frame and curtain walls. Modern skyscrapers often have a tubular structure, and are designed to act like a hollow cylinder to resist lateral loads (wind, seismic).

A. _____

A skyscraper needs careful planning before it can be built. First a big hole a few stories deep is dug into the earth. Sometimes this foundation reaches into solid rock. Then steel, concrete beams and columns are placed into it. They carry the weight of the superstructure.

When the foundation is finished cranes are used to raise a steel frame up into the sky. The pieces of this frame are bolted together. As it moves upward other workers lay floors.

A skyscraper must be able to hold off strong winds. Modern buildings are able to swing a few metres in each direction, like a tree, without damaging the structure.

B. _____

Corridors, staircases, elevators, heating systems, air conditioning and electrical systems belong to the most important inner elements of a skyscraper.

Pumps bring clean water to all parts of the skyscraper, the drainage system carries away water and waste materials. Air conditioning and heating systems control the temperature in the building the whole year round. Electrical systems provide power throughout the building and wires carry electricity to each floor.

C. _____

Two discoveries in the middle of the 1800s made it possible to build modern skyscrapers. Before the Industrial Revolution brick and stone walls carried the weight of buildings. As each floor was very heavy, it was impossible to build very high houses. In the middle of the 19th century steel became an important building material. This metal was strong and light. Architects could now construct a steel skeleton to support very tall buildings.

Skyscrapers would have been useless if people had to walk up and down many flights of stairs. In 1853 an elevator safe enough to carry passengers was invented by Elisha Graves Otis.

During the early 20th century major cities, especially in America, began to fight for the tallest buildings in the world. For four decades the Empire State Building in New York was the world's highest structure. The 381 metre high landmark has 102 stories and was completed in 1932.

D. _____

Today the world's tallest buildings no longer stand in America. Other countries, mainly in Asia, have entered the prestigious race for the tallest structures in the world. The 452 metre high Petronas Towers in Malaysia, completed in 1996, became the first skyscraper outside the US to climb the top of the list. The Burj Dubai, at the height of 828 metres, is currently the tallest building in the world (Fig. 26), but the Jeddah Tower in Saudi Arabia which is expected to be completed in 2019 will be over 1000 metres high (167 floors). The list of the World's tallest buildings includes 130 buildings which are higher than 300 metres. The Federation Tower in Moscow, at the height of 374 metres, is 34th in the list.

THE WORLD'S TALLEST BUILDINGS

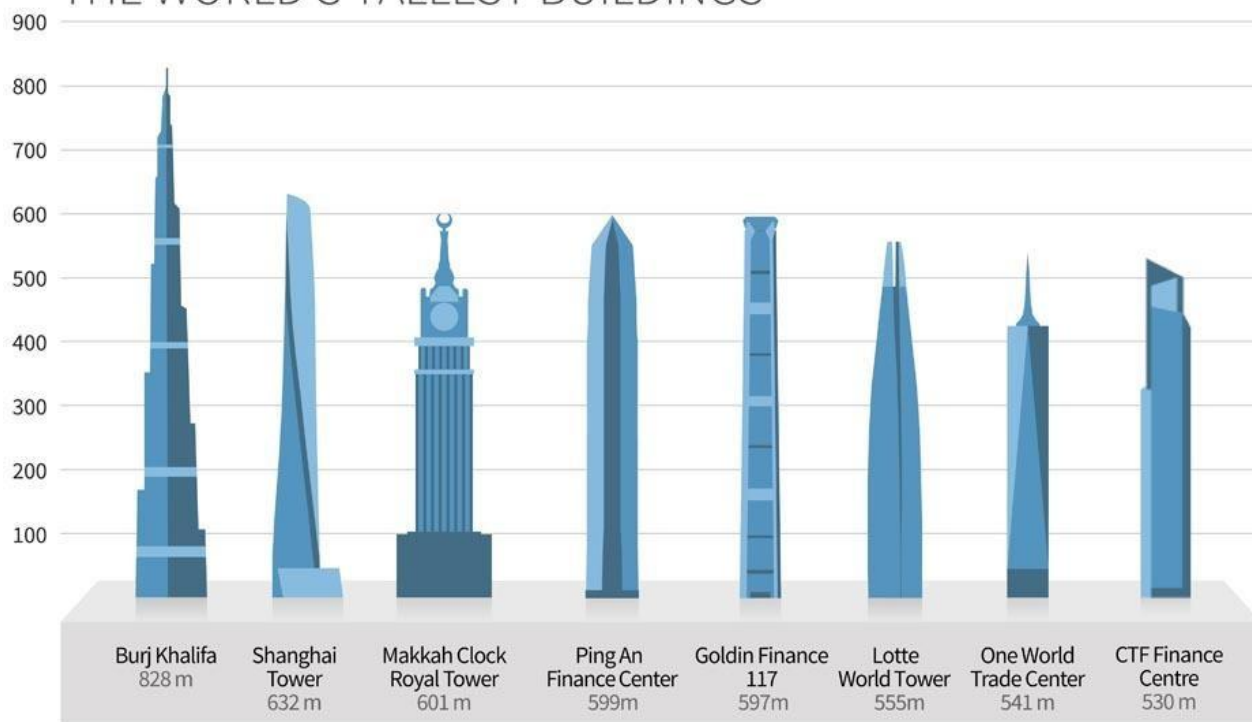

Source: www.emporis.com

Fig. 26. The Tallest Buildings in the World

Exercise 6. Answer the questions.

1. A skyscraper is a tall building higher than 50 floors, isn't it?
2. What are the differences between early and modern skyscrapers?
3. Why are skyscrapers designed to act like a hollow cylinder?
4. What are the main steps in building a skyscraper?
5. What inner elements of a skyscraper can you name?
6. Why is steel the best building material for skyscrapers?
7. Who invented an elevator?
8. What is the tallest building in the world? Where is it?
9. Is it possible to build a skyscraper having the height of 1 km?
10. What is the tallest building in your city? How tall is it?

Exercise 7. Fill in the blanks using the information from text A.

1. One common feature of skyscrapers is a steel framework that supports ... walls. A. Load-bearing.
B. Curtain.
C. Framed.
2. Modern skyscrapers often have a ... structure. A. Tubular.
B. Arched.

C. Panel.

3. Steel, concrete beams and columns are placed into foundations to carry the weight of the A.

Footing.

B. Roof.

C. Superstructure.

4. ... are used to raise a steel frame up into the sky. A.

Elevators.

B. Cranes.

C. Bulldozers.

5. Pumps bring ... to all parts of the skyscraper. A.

Electricity.

B. Clean water.

C. People.

6. The ... carries away water and waste materials. A.

Wires.

B. HVAC system.

C. Drainage system.

7. Before the Industrial Revolution ... walls carried the weight of buildings. A.

Steel and concrete.

B. Brick and stone.

C. Wood and glass.

8. For four decades the ... in New York was the world's highest structure.

A. BurjKhalifa.

B. Empire State Building.

C. Federation Tower.

9. Today the world's tallest buildings stand in

A. Asia.

B. America.

C. Europe.

10. Currently the tallest building in the world is A.

828 m.

B. 1000 m.

C. 452 m.

Exercise 8. Write the adjective forms of these words. Use Text A to help you. Then use them in your own sentences.

1. Height.
2. Possibility.
3. Tube.
4. Depth.
5. Solidity.
6. Strength.
7. Use.
8. Safety.

Exercise 9. Group A should read about the Burj Dubai Tower and Group B about the Federation Tower. Read your articles and answer the questions. Then explain briefly to someone from the other group what you have learnt from the article. Complete the table while listening to your partner. Then read the other person's article and check the answers.

Skyscrapers	Burj Dubai	Federation Tower
Characteristics		
Location		
Height		
Floors		
Period of construction		
Cost		
Elevators		
Building materials		
Usage		
Observation platform (floor)		

A. Burj Dubai

It is a super tall skyscraper in Dubai. At the cost of about 4 billion dollars the tower symbolizes Dubai as a world city. Construction of the BurjKhalifa began in 2004. The building was opened in 2010.

The building has 160 stories. The foundation has been laid 50 metres into the ground.

The Y-shaped tower consists of stainless steel and glass. It rises to the sky in steps from the middle of a man-made lake. In Islamic architecture these steps symbolize rising towards heaven.

The tower has apartments, shops, swimming pools, spas and observation platforms on the 124th floor and 148th floor. It also has the first hotel owned by Italian" s fashion tsar Giorgio Armani.

57 elevators carrying 40 people each move passengers at 18 meters/second, a new world record.



Fig. 27. Burj Dubai (828 m.)

Questions

1. How long did it take to build this skyscraper?
2. What is the construction cost?
3. How many floors does the building have?
4. What materials have been used?
5. Does it symbolize anything?
6. Is it possible for tourists to visit it?
7. How many elevators are there?
8. Do you like its shape?

B. Federation Tower

The Federation Tower in Moscow is the tallest building in Europe. The construction began in 2003 and finished in 2016. Total construction cost for the complex is estimated to be 1.2 billion dollars.



The complex consists of two towers built on one podium. The Tower East is a 95-storey structure. The Tower West is a 63storey structure. 67 high-speed elevators carrying 20 people each are installed there. The building accommodates offices, hotels and apartments. An observation platform is located on 75th floor. Currently, 61st floor of the Tower West accommodates the highest restaurant in Moscow, “Sixty”. The building also features the highest digital clock in the world.

According to the builder of the tower, concrete grade B90 is used for its construction. It is twice as strong as regular concrete and allows the skyscraper to withstand a direct hit of an aircraft.

Fig. 28.Federation Tower (374 m.)

Questions

1. How long did it take to build this skyscraper?
2. What is the construction cost?
3. How many floors does the building have?
4. Is it a residential building or an office block?
5. What materials have been used?
6. How many elevators are there?
7. Is it possible for tourists to visit it?
8. Do you like its shape?

Exercise 10. Write a short article about the Shanghai Tower using the data below. Use the articles in exercise 9 as examples.

Location

Shanghai, China

Technical Data Height: 632 m.

Floors: 121.

Construction: 2008-2015.

Elevators: 106.

Building costs: \$2.4 billion.

Structure in General

Structural material: composite structure.

Foundation system: pile foundation.



S
hanghai World Financial Center (492 m.)

Usage

Residential, commercial, hotel, shopping centre, observation deck (119 floor).

Exercise 11. Read about the skyscrapers with the fastest elevators in the world and answer the questions.

1. What is the fastest elevator in the world? Where is it?
2. Where can passengers travel the longest distance without exiting?
3. What building has the largest number of elevators?
4. Where are the most unusual elevators?
5. What is the most expensive elevator?

Yokohama Landmark Tower, Japan | Elevators by Mitsubishi

Located in the 296m-high Yokohama Landmark Tower this Mitsubishi elevator manages a speed of 45km/h. With a total of 79 elevators, the building has the fastest elevator in Japan. It only takes 40 seconds to travel from the second to the 69th floor. Each of these race-car like elevators have the price of over \$2 million.

BurjKhalifa, UAE | Elevators by Otis

No elevators are installed to travel all 160 floors of the BurjKhalifa tower. The Sky Lobby is an intermediate floor where residents, guests, office staff change from an express elevator to a local elevator, which stops at every floor within a certain segment of the building. Burj Dubai" s Sky Lobbies are located on level 43, 76 and 123. The BurjKhalifa tower offers the world's fastest double-decker elevators, with the passengers able to travel the longest distance currently possible, exiting at the world's highest stop - 638m up the building. The double-decker elevators have a capacity of 14 people per cabin. A maximum elevator speed is 36 km/h. Each one of the elevators costs around \$5 million. The skyscraper contains a total of 57 elevators.

Taipei 101, Taiwan | Elevators by Toshiba

With a building height of 509m (101 floors), passengers are catapulted at a speed of 60 km/h, from the fifth to the 89th floor of Taipei 101. The ride lasts 37 seconds, at the end of which passengers step out already 382 metres above the ground at the observation floor. Each elevator (there are 61) costs more than \$2 million.

Exercise 12. Watch video 5.1. What is the correct order of the ideas in the video? Underline the keywords before listening.

WHY WE SHOULD BUILD WOODEN SKYSCRAPERS

https://www.ted.com/talks/michael_green_why_we_should_build_wooden_skyscrapers

1. Mass timber panels for 30-story tall buildings.
2. Three billion people in need of a new home.
3. The influence of his grandfather and son.
4. A completely different behaviour in the building made of wood.
5. Deforestation.
6. Mother Nature" s fingerprints in the built environment.
7. The Eiffel Tower moment.
8. Fire.
9. Steel and concrete as the materials with high greenhouse gas emissions.
10. Using wood to store the carbon.

Text B

Exercise 13. Match the words with their meanings.

1. Application.	A. Оздоблення.
-----------------	----------------

2. Successive.	В. Шар.
3. Layer.	С. Робоча зона.
4. Entire.	Д. Будівля без обробки.
5. Suitable.	Е. Практичне застосування.
6. Contourcrafting.	Ф. Доступний.
7. Transportable.	Г. Справлятися.
8. Flat ground slab.	Н. Пересувний.
9. Rails.	І. Контурне будівництво.
10. Footprint.	Ж. Рейки.
11. Gantry crane.	К. Відповідний.
12. Nozzle.	Л. Збирати, монтувати.
13. Affordable.	М. Ручна праця.
14. Manual labour.	Н. Плоска фундаментну плиту.
15. Shell.	О. Наступний один за іншим.
16. To assemble.	Р. Портальний кран.
17. To handle.	Q. Цілий.
18. Finishes (noun).	Р. Носик, форсунка, наконечник.

Exercise 14. Read this article about 3D printing in construction. Five sentences have been removed from it. Choose from the sentences A-F the one which fits each gap (1-5). There is one extra sentence which you do not need to use.

- A. A nozzle, driven by the computer, then delivers layers of concrete.
- B. It is only since 2000 that it has become affordable.
- C. In 2015, they announced they had printed an entire villa and a five-storey apartment building.
- D. It may allow faster and more accurate construction of complex items lowering labour costs and producing less waste.
- E. The house was planned to be printed in December 2014, but this deadline wasn't met.
- F. All of them would still take a big amount of time and manual labour to be installed into the 3D printed shell in traditional ways.

3D PRINTING IN CONSTRUCTION

3D printing was first developed in the 1980's, but at that time it was a difficult and expensive operation and so had few applications. (1)___.

A 3D model of the item is created by computer aided design (CAD). The printer then reads the design and lays down successive layers of printing material. 3D printing can be used to create small complex components or to 'print' entire buildings. (2)___ . It may also enable construction to



be undertaken in dangerous environments not suitable for human beings.

Professor Behrokh Khoshnevis at the University of California has developed a process of 'contour crafting' and is testing a giant transportable 3D printer that can build the walls of a house in 24 hours. The robotic system requires a flat ground slab with underground services in place. Rails are installed near the footprint to take a gantry crane that builds the house. (3)____. The layers form an inner and outer skin for each wall, leaving them to be filled later with insulation or concrete.

A Chinese company Winsun used large 3D printers to build a group of ten small houses in one



g. 31. 3D Printed Apartment Building by Winsun, 2015

day. To achieve this, big segments of the structures are 3D printed on their factory using a mixture of concrete and construction waste. Each 3D printer is 6 meters tall, 10 meters wide and 40 meters long. Once all the components have been fabricated, they are shipped in and assembled together, just as if they were Lego bricks. According to the company, this method allows them to save up to 60% of the materials usually needed with traditional building methods and requires 80% less labor, leading to more affordable housing. Winsun believe it will be possible to use the technique to build even skyscrapers in the future. (4)____.

However, at present none of these systems can handle major elements of the building, such as electrical services, plumbing, doors, windows and finishes. (5)____. Also, studies on structural stability against earthquakes and winds are yet to be done before anyone can safely live in a 3D printed house.

Exercise 15. Is it True or False?

1. 3D printing was invented in 2000.
2. A 3D model of the house is created by CAD.
3. This technology decreases labour costs, but produces more waste.
4. The process of 'contour crafting' was developed by a Chinese company Winsun.
5. 3D printed walls can be filled with insulation or concrete.
6. It will never be possible to use this technique to build skyscrapers.
7. There are no 3D printers that can create plumbing, doors, windows and finishes.
8. Studies on structural stability have shown that 3D printed houses are very safe.

Exercise 16. What do these numbers refer to?

1. 2015.
2. 6.
3. 60.
4. 2000.
5. 2014.

- 6.5.
- 7.24.
- 8.1980s.

Exercise 17. Complete the summary using the words from the text.

3D printing was developed in the 1980s, but only since 2000 it has become (1) First, a 3D model is created by CAD. Then the printer reads the design and (2) ... successive layers of printing material. This technology may allow faster construction lowering (3) ... and producing (4) Professor Behrokh Khoshnevis invented a process of 'contour crafting'. Rails are installed near the footprint to take a (5) ... that builds the house. A (6) ... , driven by the computer, delivers layers of concrete. Winsun used large 3D printers to build ten small houses in one day. All the components were 3D printed on their factory. Then they were shipped in and (7) ... together. However, nowadays these systems can't handle such (8) ... of the building as electrical services, plumbing, doors, windows and finishes.

Exercise 18. Speak about 3D printing using the words and word combinations below.

1. To be developed.
2. Affordable.
3. To lay down.
4. Successive layers.
5. Entire buildings.
6. To lower labour costs.
7. To produce less waste.
8. 'Contour crafting'.
9. Rails.
10. Gantry crane.
11. Nozzle.
12. Layers of concrete.
13. To be fabricated, shipped in and assembled together.
14. A five-storey apartment building.
15. Electrical services, plumbing, doors, windows and finishes.
16. Structural stability.

Exercise 19. Watch video 5.2 and choose the correct answer.

WORLD'S FIRST 3D PRINTED BUILDING OPENS IN DUBAI

https://www.youtube.com/watch?v=yirGx_3D-0U

- a. What building material is used?



- A. Construction waste
- B. Gypsum
- C. Cement

Fig. 32. First 3D Printed Office Building, Dubai, 2016

- b. What is the floor space?
 - A. 250 sq. metres.
 - B. 150 sq. metres.
 - C. 125 sq. metres.
- c. How long did it take to build this office building?
 - A. 70 days
 - B. 7 days
 - C. 17 days
- d. Where is it situated?
 - A. In the suburbs of Dubai.
 - B. Near the Dubai International Financial centre.
 - C. Near the Princess Tower
- e. What is the Dubai's strategy for the future?
 - A. To have 25% of the buildings printed.
 - B. To lower labour costs by 30%.
 - C. To have all the buildings in the Emirates printed by 2030.

Text C

Exercise 20. Choose the correct definition for each of the bold words.

1. **Advances** in digital technology are creating a wave of innovation in the construction industry.
 - A. Progress in the development.
 - B. Social events to raise money.
2. Cement is one of the largest **contributors to** harmful carbon emissions.
 - A. Something that helps to cause something to happen.
 - B. A new device or method.
3. Photovoltaic glazing can help buildings generate their own electricity by turning the whole **building envelope** into a solar panel.
 - A. Finishes.
 - B. External structure.
4. Modular construction is very popular where a building is constructed **off-site** using the same standards as traditional on-site construction.
 - A. Offline.
 - B. Happening away from the building area.
5. It **limits** environmental damage delivering components as and when needed.
 - A. Prevents from being larger.
 - B. Increases.

Exercise 21. Complete the sentences using the words from the box.

insulate	remain	cracking	drywall
steel reinforcement	sustainability benefits	electricity	

1. ... is usually caused by exposure to water and chemicals.
2. Limestone will cover the crack before water and oxygen has a chance to corrode the
3. Heat transmission through walls passes directly through the building envelope, masonry, block or stud frame to the internal cladding such as
4. Aerogel can be used to ... studs.
5. Construction costs ... , while cladding costs are replaced.
6. It generates ... from pedestrian footfall.
7. It has strong ... , from fewer vehicle movements to less waste.

Exercise 22. Read and translate the text.

TOP 5 CONSTRUCTION INNOVATIONS

New materials and energy, design approaches, as well as advances in digital technology, are creating a wave of innovation in the construction industry. Here are 5 of the most exciting developments.

1. SELF-HEALING CONCRETE

<http://raconteur.net/public/img/articles/2015/06/selfhealing-concrete.jp>Cement is one of the most widely used materials in construction, but also one of the largest contributors to harmful carbon emissions, said to be responsible for around 7% of annual global emissions. Cracking is a major problem in construction, usually caused by exposure to water and chemicals. Researchers at Bath University have



Fig. 33. Self-healing Concrete

developed self-healing concrete using a mix containing bacteria within microcapsules, which will germinate when water enters a crack in the concrete to produce limestone, covering the crack before water and oxygen has a chance to corrode the steel reinforcement.

2. THERMAL BRIDGING

http://raconteur.net/public/img/articles/2015/06/13624112723_17cf770bc4_o.jpEfficient insulation material is becoming very important in the construction industry. Heat transmission through walls passes directly through the building envelope, masonry, block or stud frame to the internal cladding such as drywall. This process is known as “thermal bridging”. Aerogel is considered one of the



most effective thermal insulation materials. This can be used to insulate studs, which can increase overall wall R-value (a measure of thermal resistance) by more than 40 %.

3. PHOTOVOLTAIC GLAZING



<http://raconteur.net/public/img/articles/2015/06/polysolar.jp> Photovoltaic glazing can help buildings generate their own electricity by turning the whole building envelope into a solar panel. Companies provide

Fig. 35. Photovoltaic glazing

transparent photovoltaic glass as a structural building material forming windows, façades and roofs. This technology is efficient at producing energy even on north-facing, vertical walls. As well as saving on energy bills, its cost is only a little higher in comparison with traditional glass, since construction costs remain, while cladding costs are replaced.

4. KINETIC FOOTFALL

<http://raconteur.net/public/img/articles/2015/06/canary-wharf-kineticenergy-pads.jp> There is a technology that enables flooring to harness the energy of footsteps. It can be used indoors or outdoors in high traffic areas, and generates electricity from pedestrian footfall. It has already been used in a football pitch in Rio de Janeiro to help power the floodlights around the pitch.



Fig. 36. Kinetic Footfall

5. MODULAR CONSTRUCTION



<http://raconteur.net/public/img/articles/2015/06/modular-construction.jp> Modular construction is very popular where a building is constructed off-site using the same materials and designed to the same standards as traditional on-site construction. It limits environmental damage delivering components as and when needed. It also has strong sustainability benefits, from fewer vehicle movements to less waste. With up to 70 % of a building produced as components, **Fig. 37. Modular Construction** it allows a move towards “just in time” manufacturing and

delivery. In the United States and UK, Chinese developer Broad Sustainable Building recently completed a 57-storey skyscraper in 19 working days using this method.

Exercise 23. Write your own questions to the text above. Your groupmates will have to answer them.

Exercise 24. Complete the sentences by changing the words in CAPITALS to the correct form (noun, adjective, adverb, verb).

1. Here are 5 of the most exciting DEVELOP
2. Cement is one of the most ... used materials in construction. WIDE
3. It is ... for around 7% of annual global emissions. RESPONSIBILITY
4. Water and oxygen has a chance to ... the steel reinforcement. CORROSION
5. Efficient ... material is becoming important nowadays. INSULATE
6. Heat ... through walls passes directly through the building envelope. TRANSMIT
7. It limits ... damage. ENVIRONMENT
8. It has strong sustainability benefits, from fewer vehicle ... to less waste. MOVE

Exercise 25. Translate the following words and word-combinations. The text above will help you.

1. Проектне рішення.
2. Широко використовується.
3. Шкідливі викиди вуглецю.
4. Утворювати вапняк.
5. Викликати корозію сталеві арматури.
6. Ефективний ізоляційний матеріал.
7. Кам'яна кладка.
8. Гіпсокартон.
9. Підвищити коефіцієнт опору теплопередачі.
10. Виробляти електрику.
11. Сонячна панель.
12. Витрати на облицювання.
13. Забезпечувати електроенергією прожектор.
14. Збиток, нанесений навколишньому середовищу.
15. Виробництво і доставка.

Exercise 26. Watch video 5.3 and say if the statements are True or False.

MODULAR CONSTRUCTION

https://www.youtube.com/watch?v=CpwE_dTgJbA

1. Modular construction is eco-friendly, but it is not cost-effective.
2. Construction is non-stop all year round.
3. Numerous components can be built simultaneously.
4. The process of construction results in 40% waste.
5. Quality craftsmanship is guaranteed.
6. There are some differences in building codes for modular and traditional houses.
7. Building materials are stored outdoors.
8. Modular buildings are 15% more energy efficient than typical site-built structures.



Fig.38. Modular Construction

9. Modules are constructed to withstand travel by road and placement by crane.
10. Screws and bolts, nails, straps and glued joints do not make modular buildings stronger than traditional ones.

Exercise 27. Work in small groups. Make an advertisement of one of the inventions described in Text C (or choose another important invention in construction). Watch the OTIS ELEVATOR advertisement as an example (video 5.4).

Otis SkyRise® Elevator: <https://www.youtube.com/watch?v=I6TwHXx6jNQ>

Exercise 28. You are going to have a competition with your groupmates. The first one to complete the task is the winner. Write down:

1. Five modern construction technologies.
2. Four skyscrapers.
3. Three elements of a skyscraper.
4. Two new building materials.
5. One famous civil engineer.

Exercise 29. Imagine you would like to post a comment on a construction website on one of the following topics. Write a draft in your notebook.

1. Are skyscrapers really important?
2. A skyscraper in the heart of the city. Is it a problem?
3. An 87-storey skyscraper in your city. Is it a myth or reality?
4. Robots as construction workers. Do the advantages outweigh the disadvantages?
5. Amazing construction technologies of 21st century.

The image shows a 'Post a Comment' form with a teal border. The form is titled 'Post a Comment' and contains the following fields and labels:

- Name (required):** A text input field.
- Mail (will not be published) (required):** A text input field.
- Website:** A text input field.
- Comment (required):** A large text area for writing the comment.
- SUBMIT**: A teal button at the bottom left of the form.

UNIT 3

SAFETY ON SITE



Exercise 1. Before considering health and safety issues, some basic occupational health and safety definitions are required because it seems important to have a clear understanding of the nature and working conditions in the construction industry. Complete the vocabulary organizer with the following words: *Health, Safety, Welfare, Environmental protection, Accident, Risk.*

Word	Drawing or Symbol for Word

Predicted meaning of word: _____

Definition from dictionary: _____

Based on the dictionary's meaning, use this word in a sentence: _____

Exercise 2. Fill in the KWL Chart. In the first column, write what you already know about health and safety in construction. In the second column, write what you want to know about it. After you have completed this unit, write what you learned in the third column.

What I Know	What I Want to Know	What I Learned

TEXT A

Exercise 3. The Occupational Health and Safety Act protects workers by making their workplace a safe place. Read the following act below and complete it with a word from the box.

participate	broken	Safe	violations
unsafe	condition	supervision	hazards
Representative	solve		

By law, the Act must be posted in every workplace. The Act gives workers three basic rights:



- the right to know about health and safety
- the right to in keeping your workplace safe and healthy. Workers can give ideas and complain about problems;
- the right to refuse work that you think is

Employers and workers must work together to identify and health and safety problems in the workplace. The employer must do everything possible to protect worker's health and safety in the workplace. Employers must:

- give workers the information, training and they need to protect their health and safety;
- make sure work procedures are followed and equipment is used properly;
- help the health and safety committee
- keep safety equipment in good

Workers share the responsibility for health and safety in the workplace.

Workers must:

- use the safety equipment your employer says to use;
- tell your employer if you see any equipment or safety devices;
- report any to the employer;
- not work or operate equipment in a way that could be dangerous to themselves or anyone else in the workplace.

Exercise 4. Is it True (T) or False (F)?

- | | |
|---|-----|
| 1. The Act should be hidden from the employees. | T/F |
| 2. There are three basic rights that workers have. | T/F |
| 3. Employees can't complain about their problems. | T/F |
| 4. If the worker thinks that his work is unsafe, he has the right to refuse. | T/F |
| 5. Employers don't have to give workers the information, training and supervision they need to protect their health and safety. | T/F |
| 6. All safety equipment must be kept in good condition. | T/F |
| 7. Workers may use any safety equipment without employers' permission. | T/F |
| 8. If workers see any broken equipment, they must tell their employer. | T/F |
| 9. If there are any violations, workers must report to their employer. | T/F |
| 10. Workers must be careful while working or operating equipment. | T/F |

Exercise 5. Match the words from the text (Ex. 3.) to make phrases. Then use them in your own sentences.

- | | |
|------------------------|--------------------|
| 1. To give. | A. Place. |
| 2. To share. | B. Work. |
| 3. To report. | C. Hazards. |
| 4. To complain about. | D. Supervision. |
| 5. Good. | E. Equipment. |
| 6. Safety. | F. Responsibility. |
| 7. Basic. | G. Condition. |
| 8. To refuse. | H. Violations. |
| 9. Safe. | I. Problems. |
| 10. Health and safety. | J. Rights. |

Exercise 6. Put the words in the correct order to make complete sentences.

- safety/There/ about/ the/ is/ to/ health/ know/ and/ right/ hazards
- problems/ and/ can/ about/ give/ complain/ Workers/ ideas
- the/ There/ work/ unsafe/ to/ right/ that/ refuse/ is/ you/ is/ think
- condition/ must/ in/ Employers/ equipment/ good/ safety/ keep
- and/ responsibility/ for/ Workers/ safety/ the/ health/ share
- your/ to/ safety/ must/ the/ use/ employer/ says/ equipment/ use/ Workers

Exercise 7. Unscramble the words by placing the correct letter in the boxes. Use the numbered boxes to complete the answer to the riddle.

RIDDLE: An action that is in opposition to a law, agreement, principle etc.?

TAYSEF	GTIRH	VINENSPURSO	ROKW
<input type="text"/>	<input type="text"/>	<input type="text"/>	<input type="text"/>
5 2 6 1 3 8			
DINOTOICN	POLIMCAN	NATINRIG	
<input type="text"/>	<input type="text"/>	<input type="text"/>	
9	7	4	

ANSWER:

<input type="text"/>	<input type="text"/>	<input type="text"/>	<input type="text"/>	<input type="text"/>	<input type="text"/>	<input type="text"/>	<input type="text"/>	<input type="text"/>
1	2	3	4	5	6	7	8	9

Exercise 8. Watch Video 6.1 and fill in the gaps.

H&SAW ACT

<https://www.youtube.com/watch?v=3Yq5lmqn8Y>

The Health and Safety at Work Act is _____. It is applied to all work _____ and activities and to everyone whether they are employees, _____, directors or even they are selfemployed. The purpose of the Act is to _____ the health, safety and welfare of anyone in a work environment and also anyone who is likely to be affected by workplace dangers, such as a person walking on the _____.

It's not only people that are involved; the Act also controls the _____ into the atmosphere of noxious or offensive substances. In general terms, the Act says it's the _____ of an employer to provide a safe place of work and the employees' responsibility to cooperate with their employer to keep it that way. That means taking care of your own _____ and others using equipment properly and not _____ with anything that's provided in the interests of safety.

This law is _____ by inspectors from the Health and Safety Executive. These inspectors can visit the workplace without warning and have a right to talk to employees but even more important they do have powers to _____ a firm or an individual for breaking the Health and Safety Law.

Exercise 9. Watch the video again and answer the questions.

1. What is The Health and Safety at Work Act?
2. What is the purpose of the Act?
3. Does the Act control only people?
4. Who is in charge of providing a safe place of work?
5. How can employees take care of their safety?
6. Who is this Law enforced by?
7. What is an inspector's responsibility?
8. What are the consequences if the Law is broken?

Exercise 10. Create a diamante poem. Use the poem frame below, which asks you to use different parts of speech to describe The Health and Safety Act.

Topic- noun			
adjective	Adjective		
verb	Verb		Verb
	four-word phrase		
verb	Verb		Verb
adjective	Adjective		
noun			

TEXT B

Exercise 11. Working in the construction industry is both rewarding and satisfying but you could be exposed to various risks. Use the Think - Pair -Share strategy to complete the task:

- Think about the various health and safety risks that could be found on the construction site.
- Pair up and share your thinking with a partner, discuss your ideas and ask each other questions on the topic.
- Share your thoughts with a class. You are to choose who will present your ideas.

Exercise 12. Look at the list of some health and safety risks below. Match the pictures with the following words and phrases.

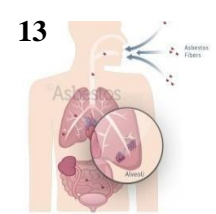
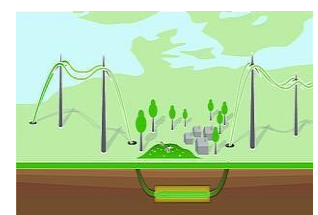

Risk of vehicle overturning;

Falls from height;

Proximity to flammable or combustible materials;

Cancer risk from Exposure to asbestos;

Slips trips and falls due to untidy work area;

Cuts and abrasions;

Sunexposure;

Exposure to noise.

Exposure to electricity.

Overhead and underground cables;

Climbing steps and working platforms;

Risk of eye injury from flying particles and dust;

Manual handling activities;

Using various types of machinery and tools;

Moulds, fungi and bacteria;

Hand and foot injury;

Exercise 13. Match the words with their definitions.

1. To sustain.	A. An open container with a handle, used for carrying and holding things, especially liquids.
2. Scaffolding.	B. A large truck for transporting heavy loads, with a back part that can be raised at one end so that its contents fall out.
3. Trench.	C. A structure of metal poles and wooden boards put against a building for workers to stand on when they want to reach the higher parts of the building.
4. Collapse.	D. To experience loss, injury, damage etc.
5. Dumper.	E. A long narrow open hole dug in the ground.
6. Bucket.	F. A bar or fence put for safety at the edge of something such as a road, a bridge, or stairs.
7. Sling.	G. Without success.
8. Water tank	H. When something suddenly falls down.
9. In vain	I. A metal tool with a sharp edge, used to cut wood or stone.
10. Chisel	G. A device that uses a strap, piece of cloth, or ropes for supporting, lifting, or carrying objects.
11. Guard rails	K. A large container for storing water.

Exercise 14. Match the words with their meanings.

1. To pile up.	A. Тягти.
2. Stack.	B. Стопа.
3. Sufficient.	C. Уважний.
4. Fencing.	D. Складати.
5. Vigilant.	E. Огорожа.
6. Cable.	F. Пристрій захисного відключення.
7. To drag.	G. Достатній.
8. Earth leakage circuit breaker.	H. Кабель.

Exercise 15. How much do you know about basic rules for safety? Complete the following sentences by underlining the correct words (A) and then fill in the table by sorting them into three categories (B). A.

- Sort out materials and pile them up safely. The stacks should not be too *small / high*.
- Before / After* you operate a machine, ensure that the dangerous part of the machine has been installed with a guard.
- Do not wear / Wear* protective equipment.
- Keep passages clear *all the time / from time to time*.
- Do not drink or take drugs *while working / after work*.
- Avoid going to any area with *insufficient / sufficient* lighting as there may be some dangerous places which have not been provided with fencing.
- Beware of *window / floor* openings and ensure that they are fenced or covered.
- Keep vigilant *all the time / occasionally* and watch out for moving cranes, hooks or other lifting equipment.
- Store / Remove* wastes as soon as possible.
- Before you use any electrical installation or tool, check the *condition / availability* of its electric cables.
- Pay attention to personal *nutrition / hygiene*.
- Avoid dragging electric cables on the ground or allowing the cables to come into contact with *water / sand*.
- Familiarize with the *location / colleagues* and the operation of fire-fighting equipment.
- Play / Do not play* in the workplace.
- Use electrical tools installed *with / without* an earth leakage circuit breaker.
- Report / Do not report* to your supervisor immediately if you notice any unsafe condition.
- Use and handle chemicals with *assistance / care*. **B.**

Tidy up construction sites	Safety measures	Personal Safety

Exercise 16. Work in pairs. First, write your own questions to Ex.15. Then take turns to ask and answer them.

Exercise 17. You are divided in a group of 6. Each of you is given one situation from the following. Read your card with an example of the accident happened on the construction site and retell it. Your partners are to ask questions about the accident and fill in the report form. Those who are the first to finish, win.

Example 1

David Thompson is a 42-year-old man who is likely to remain permanently disabled following an industrial accident in which he sustained serious head injuries that occurred as he fell 3.5 metres from a scaffolding structure he was using to access his work on a residential development.

Example 2

Steven Owens was a 45-year-old married man. He died as a result of a trench collapse he was working in; a dumper was filling gravel into the trench at the time of the collapse, the excavator driver had to support the dumper with his bucket to prevent it from following in as the ground gave way.

Example 3

A 20-year-old Gary Simmons died as a result of falling 5 metres from a ladder that he was using to attach a sling to a water tank, the ladder slipped as it was not tied or footed.

Example 4

Jeffrey Jones is a 33-year-old groundworker. He was struck by a concrete lorry and seriously injured as he was talking on his mobile phone; other workers tried in vain to signal to him but could not prevent the accident. **Example 5**

Scott Parker is a 25-year-old construction worker who suffered injury when using a hammer and chisel as part of the metal chisel broke and became imbedded in his eye.

Example 6

A construction company hired a 37-year-old Samuel Henderson, an independent contractor, to install windows in a house. A worker fell 14 feet from a platform that was not equipped with guard rails as required by the Construction Regulation. The worker suffered serious head injuries.

Accident Report Form	
Name	
Age	
Brief description of the accident	
Accident consequences	

Exercise 18. Watch Video 6.2 to learn more about construction safety rules and answer the following questions.

CONSTRUCTION SAFETY RULES https://www.youtube.com/watch?v=0iwe8x_LnLQ

- 1) List the hazards that put construction workers at risk.

- 2) What is the purpose of the video?
 - 3) What is the first tip about?
 - 4) What should you do to set up stable scaffolding?
 - 5) How many feet must it be from electrical power lines?
 - 6) What does the second section deal with?
 - 7) How many tips are given? What are they?
 - 8) How should you use stairways?
 - 9) What safety practices must be followed when using trenches?
 - 10) Name at least three types of personal protective equipment.
- Fig.40. The importance of following the rules**

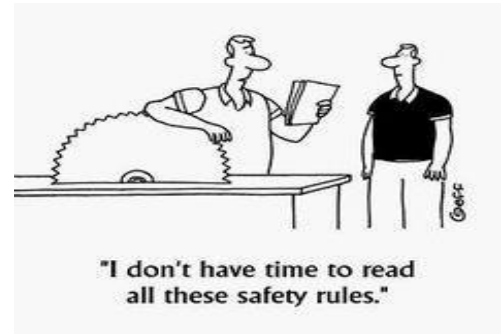

Exercise 19. Write an essay on the topic “The importance of safety rules at work”. You are to fill in the template. The following instructions will help you.

<p>Introduction: Write one or two sentences that introduce your topic, including a brief description of the main ideas.</p>	<div style="border: 1px solid black; width: 100%; height: 100%; border-radius: 10px;"></div>			
<p>Main Ideas: List the main ideas about your topic that you will include in your essay. There can be important facts you’d like to describe, points you’d like to explain, or elements you’d like to define.</p>	<table style="width: 100%; border-collapse: collapse;"> <tr> <td style="width: 33%; height: 60px; border: 1px solid black; border-radius: 10px;"></td> <td style="width: 33%; height: 60px; border: 1px solid black; border-radius: 10px;"></td> <td style="width: 33%; height: 60px; border: 1px solid black; border-radius: 10px;"></td> </tr> </table>			
<p>Supporting Details: Write at least three supporting details for each main idea.</p>	<table style="width: 100%; border-collapse: collapse;"> <tr> <td style="width: 33%; height: 60px; border: 1px solid black; border-radius: 10px;"></td> <td style="width: 33%; height: 60px; border: 1px solid black; border-radius: 10px;"></td> <td style="width: 33%; height: 60px; border: 1px solid black; border-radius: 10px;"></td> </tr> </table>			
<p>Conclusion: Write one or two sentences that will conclude your essay. These can summarize the main ideas, describe what is important about the topic, or talk about what the reader should take away from the essay.</p>	<div style="border: 1px solid black; width: 100%; height: 100%; border-radius: 10px;"></div>			

TEXT C

Exercise 20. Complete the table.

Word	Synonym/Antonym	Part of Speech	Definition	Translation
Aid				
To strike (struck/struck)				

Recovery				
Kit				
Vehicle				
Quarterly				
Accessible				
Treatment				
To bandage				
Timely				

Exercise 21. Read the text below. Match each part of the text (A–C) with the correct heading (1–3).

FIRST AID

1. Facilities
2. First aid
3. Equipment

A. _____

First aid is emergency help given to an injured or suddenly ill person using readily available materials. It may be as simple as cleaning and bandaging a minor cut on a worker's finger, or it can be complicated, such as providing care for a worker who has been struck by a piece of moving equipment. The objectives of first aid are the same regardless of the situation. They are to:



- preserve life; **Fig. 41. First Aid Station**
- prevent the injury or illness from becoming worse;
- promote recovery. **B.** _____

Employers must provide and maintain a first aid station in the workplace. Pick a location for the kit that it is accessible at all times. Companies who use service vehicles should ensure that first aid kits are provided for each vehicle. As well, provide a first aid kit when workers are operating heavy construction and maintenance equipment at a distance from the first aid station. The contents will vary according to the number of employees regularly employed in that workplace. Inspect each kit at least quarterly, then sign and date the inspection card.

C. _____

In a workplace with few employees, the first aid station may be as simple as a first aid kit placed in an accessible area. Large companies (over 200 employees) are required to have a first aid room. On construction projects, it's the responsibility of the general contractor to provide the first aid station. It should be located in the site office. On a large project, set up additional first aid stations to ensure timely access to treatment. In all cases, the regulation requires you to post "In Case of Injury at

Work” poster, a first aid kit inspection card, and the valid first aid certificates of the first aid providers in the workplace.

Exercise 22. Is it True or False?

- | | |
|--|-----|
| 1. First aid is help given to healthy people. | T/F |
| 2. The emergency help can be simple as well as complicated. | T/F |
| 3. The aim of first aid is to save life. | T/F |
| 4. It“ s employees“ responsibility to provide a first aid station. | T/F |
| 5. Each kit must be inspected quarterly. | T/F |
| 6. If the company has more than 200 employees, there must be a first aid room. | T/F |

Exercise 23. Match the words to make phrases. Then make up your own sentences with them.

- | | |
|----------------|----------------|
| 1. Accessible. | A. Card. |
| 2. Promote. | B. Help. |
| 3. Minor. | C. Equipment. |
| 4. Inspection. | D. Aid. |
| 5. Emergency. | E. Cut. |
| 6. Moving. | F. Recovery. |
| 7. First. | G. Contractor. |
| 8. General. | H. Area. |

Exercise 24. Complete the sentences by changing the words in CAPITALS to the correct form (noun, adjective, verb).

- | | |
|--|--------------|
| 1. First aid is emergency help given to an ... or suddenly ill person. | INJURY |
| 2. When a person needs emergency help, ... materials are used. | AVAILABILITY |
| 3. Location for the kit must be ... at all times. | ACCESS |
| 4. There must be provided a first aid kit when workers are ... heavy construction. | OPERATION |
| 5. First aid station should be ... in the site office. | LOCATION |

Exercise 25. Read the following emergency procedures. Number the sentences below in the correct order. Then match them with the pictures.

	GUIDE THE AMBULANCE
	Meet and direct the ambulance to the accident scene.
	PROVIDE PROTECTION
	Protect the accident scene from continuing or further hazards – for instance, traffic, operating machinery, fire or live wires.
	GET NAME OF HOSPITAL
	For follow-up, find out where the injured is being taken.

	TAKE COMMAND
	Assign the following duties to specific personnel.
	ADVISE MANAGEMENT
	Inform senior management. They can then contact relatives, notify authorities, and start procedures for reporting and investigating the accident.
	GIVE FIRST AID
	Give first aid to the injured as soon as possible.
	ISOLATE THE ACCIDENT SCENE
	Barricade, rope off or post a guard at the scene to make sure that nothing is moved or changed until authorities have completed their investigation.
	CALL AN AMBULANCE
	Call an ambulance and any other emergency services required. In some locales, dialing 911 puts you in touch with all emergency services.

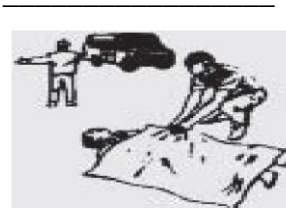
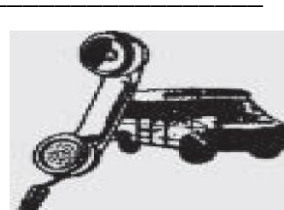
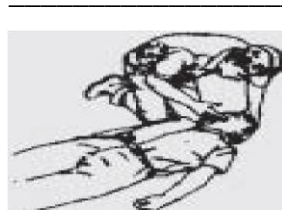
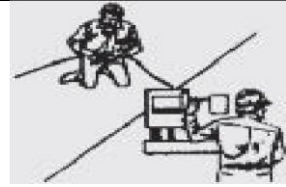
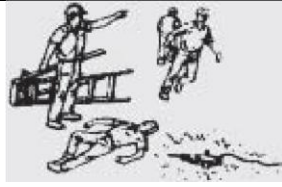

Exercise 26. In pairs, role-play making an emergency phone call for an ambulance using the role cards. Take turns to be the control assistant and the person calling. Think through an imaginary emergency scenario. Act out the phone call using mobile phones.

Student A. Caller. Plan your call. Think about each of these points. If you like, make some notes for each point.

1. The number you are calling from.
2. What has happened?
3. Your name (remember you may need to spell it).
4. Your exact location.
5. Information about any people involved in the accident (how many, their approximate age)
6. The condition of any injured people (Are they conscious? Are they breathing? Are they in shock?)

Student B. Control assistant. Use these questions to help you.

1. What number are you calling from?
2. Can you tell me what happened?
3. What is your name? Could you spell it?

4. Are you at the scene of the accident?
5. Where exactly are you?
6. Did you see what happened?
7. Is anybody hurt?
8. What's their condition?
9. Give the caller some instructions what to do until the ambulance arrives.

TEXT D

Exercise 27. You are going to read the text about safety critical work. But first, read the word list below and sort them into the following categories. The Unknown Words category is only for terms you have no idea about. Then, use a certain number of the terms to create a “gist statement” that summarizes what you predict the text will be about. Finally, complete the “To Discover” section at the end, noting specific questions that have arisen as a result of identifying unknown words or considering the gist statement.

Word List		
Drowsiness	Impaired awareness	Occupational health doctor
Loss of consciousness	Affect concentration	Side effects
General report	Restrictions	To relate problems to someone
Fit for work	Incapacity	
To carry out testing	Restricted mobility	

Categories		
Health conditions	Medical assessment	Medication
Drugs and Alcohol	Recommendation	Unknown words

Gist statement	
To Discover	

Exercise 28. Read the text. Three sentences have been removed from it. Choose from the sentences A-D the one which fits each gap (1-3). There is one extra sentence which you do not need to use.

- A.** This is the only information that an employer needs to ensure an appropriate match of worker to job.

- B.** In some cases, it may be necessary for a worker to do other tasks until the nature and extent of side effects have been established, and are properly controlled.
- C.** Workers who experience stress, anxiety or depression are unlikely to perform effectively and if stress levels are not corrected it can lead to serious problems.
- D.** These jobs are called “safety critical” and the people who do them are “safety-critical workers”.

SAFETY CRITICAL WORK

Some jobs in the construction industry involve activities that can place workers at risk, unless the person has full, unimpaired control of their physical and mental capabilities. **(1)_____.**

In particular, your employer will need to focus on health conditions that may involve:

- sudden loss of consciousness (e.g. epilepsy, some heart conditions, diabetes (particularly insulin dependent diabetes));
- impaired awareness or concentration;
- sudden incapacity;
- impaired balance or coordination;
- restricted mobility;
- impaired vision or hearing.

Before someone starts safety-critical work, it is good practice for the employer to agree what health checks and/or medical examination are required, and record the agreement. It is important to be clear which aspects of fitness are relevant to the safety-critical work, and to specify the required level.

Example: Working at Height

Your employer needs to be sure that you:

- can climb the ladder or platform;
- can see well enough (this might mean making sure you use prescription lenses);
- do not suffer from a condition which might cause you to lose consciousness or reduce your ability to concentrate. **Medical assessment**

Workers who carry out safety-critical tasks need a full medical assessment. Decisions on fitness for work can only be taken by a competent occupational health doctor.

Detailed medical assessments are confidential to the worker and the occupational health practitioner or general practitioner. However, an employer can reasonably expect the occupational health practitioner to provide a general report about individual fitness in terms of:

- fit for work;
- fit for work with restrictions;
- temporarily does not meet the fitness standard;
- doesn't meet the fitness for work to carry out specific jobs.

(2)_____.

Medication

Some medication can cause drowsiness and affect concentration. All safety critical workers should be encouraged to ask their general practitioner or pharmacist about the possible side effects of medication. **(3)_____.** **Drugs and alcohol**

You should not do construction work if you are under the influence of drugs or alcohol as you or someone else could suffer serious injury or death, but drug and alcohol testing is a complex area and

if your employer decides to carry out testing, they will need to consult with health and safety representatives and employees about the companies policy, position and procedures.

What you should do

If you think that you are suffering from any of the health and safety issues mentioned speak to your supervisor, manager or a suitable person than you can relate your problems to, don" t suffer in silence.

Exercise 29. Return to Ex. 27 and compare your answers with the text. Were your predictions right?

Exercise 30. Work in pairs. First, write your own questions to the text above. Then take turns to ask and answer them.

Exercise 31. Match the words to make phrases. Then make up your own sentences with them.

- | | |
|-----------------------|---------------------|
| 1. Fit for. | A. Conditions. |
| 2. Impaired. | B. Tasks. |
| 3. Suffer in. | C. Representatives. |
| 4. Suitable. | D. Silence. |
| 5. Unimpaired. | E. Work. |
| 6. Health. | F. Person. |
| 7. Medical. | G. Control. |
| 8. Health and safety. | H. Incapacity. |
| 9. Sudden. | I. Assessment. |
| 10. Safety-critical. | J. Vision. |

Exercise 32. Fill in the Pyramid. Then share your paper with the group.

One word describing one major idea

Two words describing a supporting detail

Three words describing another major idea

Four words describing another supporting detail

Five words describing the purpose of the text

Six important vocabulary words

Seven words telling what you learned

--	--	--	--	--	--	--	--

Eight words describing your attitude to the problem

Exercise 33. Two-Point Review. Work in pairs, first, choose 7-10 key words and phrases from Ex. 28 that represent major ideas and information. Review the information about safety critical work. Then Student A tells his/her partner everything he remembers about it. Student A can't use the checklist. As student A recalls information, student B crosses off the key words from his/her list. When student A can no longer recall information, student B asks questions based on the ideas not checked off the list. The review is finished when all words on the checklist are marked or when student A can no longer answer questions.

Exercise 34. Go online and test your knowledge on Health and Safety on Site.

<http://www.test-questions.com/cscs-test.php>

UNIT 4

SUSTAINABLE CONSTRUCTION



TEXT A

Exercise 1. Read the questionnaire and tick the best answers for you. Then read the text below and check your answers.

	YES	NO	DON" T KNOW
1. Environment is everything that surrounds us.			
2. It deals with living things and natural forces.			
3. Living things interact with the environment all the time.			
4. Sunlight is a part of the environment.			
5. Things in the environment, such as fish, sunlight and forests are called natural resources.			

Environment is the surrounding things. It includes living things and natural forces. The environment of living things provides conditions for development and growth as well as danger and damage. Living things do not simply exist in their environment. They constantly interact with it. The environment consists of the interactions among plants, animals, soil, water, temperature, light, and other living and non-living things. In biology and ecology the environment is all of the natural materials and living things, including sunlight. This is also called the natural environment. There are some people who normally call themselves environmentalists. They think we must protect the environment, to keep it safe. Things in the environment that we value are called natural resources. For example fish, sunlight, and forests.



Fig.42. The environment includes all natural materials

Exercise 2. Read the text again and choose the correct option.

Environment deals with...	The environment includes interactions among ...	Environmentalists –people who...
---------------------------	---	----------------------------------

1. Living things. 2. Natural forces. 3. Both of these.	1. Non-living things. 2. Living things. 3. Both of these.	1. Live a healthy life. 2. Take care of the environment. 3. Believe that nothing can damage our planet.
--	---	---

Exercise 3. Discuss these questions with your groupmates.

1. Do you think the environment has been getting better or worse in recent years? Why/ Why not?
2. Do you think that you live in healthy environment? For example, are the water and air clean?
3. What other problems, in your opinion, is the environment facing today?

Exercise 4. Work in pairs. Based on the information above, try to think of what environmental design is. Discuss it with your partner and present your ideas to the rest of the group.

Exercise 5. Read the paragraph and complete it with a word or phrase from the box. Compare your answers from exercise 4 with the definition given in this text.

Resources	Resilience	Evaluation	Flexibility
	Inspired	Infrastructure	

Environmental design is a framework that includes the planning, production, and (1) ... of objects of every scale, including products, buildings, parks, human settlements, and (2) ..., in a mutual relationship with the functioning and (3) ...of natural systems. Environmental design has significantly changed certain design practices. It has (4) ... environmentally reflexive landscape architects, urban designers, architects, interior designers, and engineers to consider the environmental cost of their work. As a result those practices are introducing the conservation of energy, natural (5) ..., and materials into the design process and producing objects, spaces, and landscapes of increasing durability and long-term social (6)...

Exercise 6. Match the words with their synonyms.

- | | |
|-------------------|------------------|
| 1. Evaluation. | A. Ecological. |
| 2. Flexibility. | B. Assessment. |
| 3. Conservation. | C. Joint. |
| 4. Resilience. | D. Saving. |
| 5. Mutual. | E. Strength |
| 6. Environmental. | F. Adaptability. |

TEXT B

Exercise 7. Here are some words from the text below. Read the sentences. Then write each bold word next to the correct definition. Verbs should be written in the infinitive form.

1. Environmentalism usually **refers** to the ideology of any environmental movement.
2. There are some **issues** concerning sustainability that construction engineers deal with.
3. Many buildings have been greatly **improved** by the change in construction materials.
4. Insulation should be incorporated in walls to resist passage of heat.
5. The biggest **concern** nowadays is to keep the environment safe.
6. The greatest **threats** to the sustainable development on earth are: population growth and urbanization, energy use and global warming, excessive waste generation and the subsequent pollution of soil, air, and water, transportation in cities, and limited supply of resources.
7. Air and water **support** human life.
8. The quality of food is **deteriorating** at a rapid pace.
9. Construction engineers are **responsible for** planning and designing buildings.
10. **Significant** changes in the environment of South Asia have affected cultural development in that region.

- A. _____ (v.) to get better or to make something better
- B. _____ (n.) an important subject or problem that people are discussing
- C. _____ (v.) to include something as part of another thing
- D. _____ (v.) to give strength to, maintain
- E. _____ (n.) someone or something that is likely to cause harm or damage
- F. _____ (v.) if information refers to someone or something, it relates to that person or thing.
- G. _____ (n.) a feeling of worry about something, or the thing that is worrying you
(adj.) to be the person whose duty is to deal with someone or something H. _____ (v.)
to become worse
- _____ (adj.) important or noticeable
- I. _____
- J. _____

Exercise 8. Read the title of the text. What do you think is the answer to the question in the title? Why do you think this?

Exercise 9. Read and translate the text.

WHY SHOULD ARCHITECTS LEAD ON SUSTAINABLE DESIGN?



Fig. 43. Eco-sustainable house in France

“Green” design, “environmental” design, and “sustainable” design all **refer** to the same topic often discussed today within the design community: how can we think of design as *environmentally responsible design*? Architects may wonder what the **issue** is; after all, many aspects of environmentally responsible design are already common practice. **Improved** indoor air quality is becoming an important goal for most professionals. Many methods for achieving it are being **incorporated** into the general practice. Our buildings are far more efficient than they were just 20 years ago. Architects have discovered better and more effective ways to design buildings.

Environmentally responsible design, or *sustainable* design, is not standard practice now. But it will be in a few short years, because society simply has no other option. We live in a world with growing **concerns** about the quality of the environment that surrounds and supports us, that supports human life. Environmental **threats** are real and appear to be growing. The issue is whether the earth will continue to be able to **support** human life. The question is whether the earth can support the impact of people on its air, water, and soil. The health of the environment is **deteriorating**, at an accelerating pace, because of the impact of humans.

Sustainable design, green design, and environmental design will be common practice in the future. In the near future, a design will be considered good only if it is healthy for its users and for the earth’s environment. Architects are primarily **responsible for** the decisions that affect our environment. They have a unique opportunity. For every material, system, or product decision that they make, there is a **significant** range of choices. Some are toxic to users and the earth. Others are less harmful and in some cases approach sustainability. If architects choose wisely, they have the opportunity not only to improve individual buildings, but also to help build a healthier environment for all.

Exercise 10. Answer the questions.

1. Are all aspects of environmentally responsible design already common practice?
2. What is an important goal for most professionals in this field?

3. Which buildings are more efficient: modern or the old ones? Why?
4. How can you also call “sustainable design”?
5. Can you say that our environment today is improving? Why/ Why not?
6. What design will be considered as a good one in the near future?

Exercise 11. Which paragraph...?

- a) describes the problems we are having today;
- b) describes incorporation of environmentally responsible design;
- c) describes the role of sustainable design in future.

Exercise 12. Match the words from the text to make phrases. Then make up sentences with them.

- | | |
|-------------------|-----------------|
| 1. Sustainable; | A. Pace; |
| 2. Growing; | B. Practice; |
| 3. Common; | C. Ways; |
| 4. Environmental; | D. Opportunity; |
| 5. Important; | E. Threats; |
| 6. Effective; | F. Concerns; |
| 7. Unique; | G. Goal; |
| 8. Accelerating. | H. Design. |

Exercise 13. Match the beginning of the sentence to its ending.

- | | |
|---|---|
| 1. Society has ... | A. Deteriorating. |
| 2. Environmental threats ... | B. An important goal. |
| 3. How can we think of design ... | C. Are real. |
| 4. The health of the environment is ... | D. As environmentally responsible design? |
| 5. Improved indoor air quality is ... | E. Standard practice now. |
| 6. Sustainable design is not ... | F. A unique opportunity. |
| 7. Some materials are ... | G. No other option. |
| 8. Architects have ... | H. Toxic to users and the Earth. |

Exercise 14. Discuss the questions in groups. Then choose one question and write freely for five to ten minutes in response.

1. How do you understand the term “environmentally responsible design”? What are the advantages of its usage, if there are any?
2. What would you do to improve our environment?
3. What do you think, is sustainable design common practice in Russia? If yes, then is it efficient? If no, then what are the reasons for that?

TEXT C

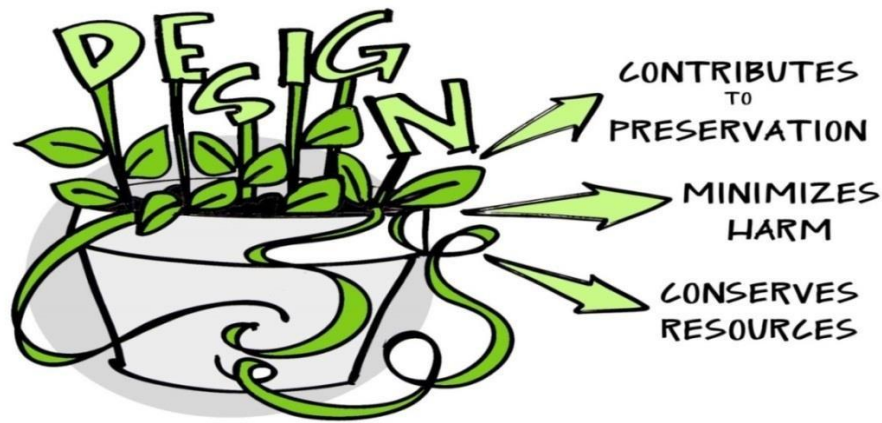

Exercise 15. Work with a partner. Look at the picture and read the characteristics of eco– design. Do you agree with them? Why/ Why not? Give your examples.

Exercise 16. Complete the paragraph with a word or phrase from the box.

self-conscious	products	incentive	design
	environmentally friendly		solutions

It is not realistic to think that it will be possible to design (1)..... buildings within the traditional design process. The traditional process allows construction engineers and architects little opportunity or (2)..... to rethink basic issues and work toward more integrated (3)..... solutions. In addition, they have many unanswered questions; they are overwhelmed with many new (4)..... coming onto the market every week; and in many cases, they do not understand the basic science. The issues, problems, and (5)..... are far from intuitive. Architects and construction engineers need a different approach to design in order to produce high–performance buildings – a (6)..... approach.

Exercise 17. Read the paragraph again and find synonyms for the words below.

- | | | | |
|------------------|-------|-----------------|-------|
| 1. Conventional: | _____ | 4. Fundamental: | _____ |
| 2. Motivation: | _____ | 5. Solving: | _____ |
| 3. United: | _____ | 6. Method: | _____ |

Exercise 18. Read and translate the text below. Match each part of the text (A–K) with the correct heading (1–11).

- | | |
|--|--|
| 1. Maintenance. | 7. Promote indoor air quality. |
| 2. Share and demonstrate sustainability. | 8. Reduce energy use. |
| 3. Program carefully. | 9. Plan for user recycling. |
| 4. Learn systematically. | 10. Use environmentally friendly building materials. |
| 5. Long–term value. | |
| 6. Construction waste. | 11. Long–term flexibility. |

THE ENVIRONMENTALLY SELF-CONSCIOUS DESIGN PROCESS

The self-conscious sustainable design process takes account of eleven factors:

- A. _____ Work with the overall building designer to maximize the use of daylight, reduce the use of electric lighting and reduce overall energy consumption. Consider the use of operable windows.
- B. _____ Select building materials based on their entire life cycle, to minimize waste and pollution at all stages while also protecting the health of the building users.
- C. _____ Make it easy for the building's users to recycle by providing appropriate space and casework to sort and store recyclable materials both at the point of use.
- D. _____ Minimize construction waste in the specifications for each material as well as a recycling requirement in the general conditions of the specification.
- E. _____ Insure that the materials selected promote health with a minimum of off-gassing that the building is well ventilated before occupancy and during use, and that microbial contamination is avoided.
- F. _____ Ensure that the overall program is necessary and minimized to reduce the overall use of resources.
- G. _____ Design for flexibility in every way possible for the long-term use of the initial and subsequent users.
- H. _____ Ensure that the building is easy to clean and maintain.
- I. _____ Work toward raising the overall environmental performance of not just a single project but all projects. Do this by learning from each to systematically improve your standard specifications, details, and other aspects of design.
- J. _____ If we are to improve the environment for all, the knowledge of how to do so cannot be only your own information. Share the knowledge gained with your colleagues and competitors as well as your clients.
- K. _____ In all ways, think of the design in terms of creating an environment of long-term value.

Exercise 19. Read the statements. Number the main ideas in the correct order (1–11). There is one main idea for each paragraph.

- ___a. The knowledge of how to improve our environment should be distributed among other people.
- ___b. It is important to select materials that provide good ventilation in the building and the absence of microbial contamination.
- ___c. To maximize the design process you need to cooperate with the overall building designer.
- ___d. You need to consider your design as a long-term contribution to the environment.
- ___e. It is vital to choose eco-friendly materials to reduce pollution and waste.
- ___f. You need to make sure that the program is essential and the use of resources is reduced.
- ___g. Designers need to improve all their projects by learning from each one.
- ___h. You must design the building that is easy to maintain.
- ___i. There should be spaces provided for sorting and storage of recyclable materials.
- ___j. Design should be flexible for long-term use.
- ___k. You need to think of construction waste reduction and recycling requirements.

Exercise 20. Match the beginning of the sentence to its ending.

1. Work with the overall building designer...
2. Select building materials...
3. Provide appropriate space and casework...
4. Minimize construction waste...
5. Insure that the materials selected promote...
6. Ensure that the overall program is...
7. Design for flexibility...
8. Ensure that the building is...
9. Work toward raising ...
10. Share the knowledge gained...
11. Think of the design in terms of...

- A. To sort and store recyclable materials.
- B. Creating an environment of long-term value.
- C. Based on their entire life cycle.
- D. For the long-term use of the initial and subsequent users.
- E. To maximize the use of daylight.
- F. The overall environmental performance of all projects.
- G. With your colleagues and competitors as well as your clients.
- H. In the specifications for each material.
- I. Health with a minimum of off-gassing.
- J. Necessary.
- K. Easy to clean and maintain.

Exercise 21. Complete the sentences using the words from the text above.

1. Work with the overall building designer to ... the use of daylight, ... the use of electric lighting and reduce overall energy
2. Select building materials to minimize ... and pollution.
3. Insure that microbial ... is avoided.
4. Design for flexibility in every way possible for the ...-... use.
5. The building is easy to clean and

Exercise 22. Match the words to make phrases

- | | |
|-----------------------------|-------------------------|
| 1)environmentally friendly; | a)windows; |
| 2)energy | b)recyclable materials; |
| 3)operable; | c)use; |

- 4) store;
- 5) promote;
- 6) long-term;
- 7) microbial;
- 8) improve;
- 9) construction;
- 10) demonstrate;

- d) standard specifications;
- e) contamination;
- f) waste;
- g) sustainability;
- h) building materials;
- i) indoor air quality;
- j) consumption.

Exercise 23. Find the key words in the word search below. Words can go in any direction.

Z	U	S	P	D	L	K	M	O	H	E	B	Q	Q	C
P	F	U	K	W	X	D	C	T	M	Y	S	Q	J	E
J	X	S	F	N	I	L	L	I	A	S	Q	T	N	B
F	D	T	D	D	V	A	G	E	T	S	M	I	G	E
P	D	A	Z	J	E	J	N	N	E	V	X	D	L	U
T	E	I	O	H	Z	I	N	E	R	Y	A	A	K	K
T	S	N	O	N	A	F	V	R	I	G	O	L	K	J
M	I	A	S	T	V	D	H	G	A	O	J	K	U	S
E	G	B	N	V	L	D	Z	Y	L	N	B	W	M	E
X	N	I	T	A	N	I	C	L	I	E	N	T	D	C
V	A	L	Z	H	X	K	S	O	V	V	C	U	W	W
M	W	I	P	O	Q	J	C	A	H	C	Q	I	A	V
O	C	T	F	I	F	E	Q	F	K	G	J	M	S	Y
K	E	Y	Y	F	L	E	X	I	B	I	L	I	T	J
I	N	F	B	O	Y	G	K	Z	X	Q	S	N	E	

Keywords

- | | | |
|----------------|---------------|--------|
| Energy | Contamination | Eco |
| Material | Waste | Design |
| Value | Maintain | Health |
| Recycling | Flexibility | |
| Sustainability | Client | |

Exercise 24. Write 7 questions about the environmentally self-conscious design process. When you finish, interview your partner.

Exercise 25. Imagine you are running a workshop on the eco-friendly design process. Prepare a mini-presentation concerning principles it should include. Be ready to answer the questions.

TEXT D

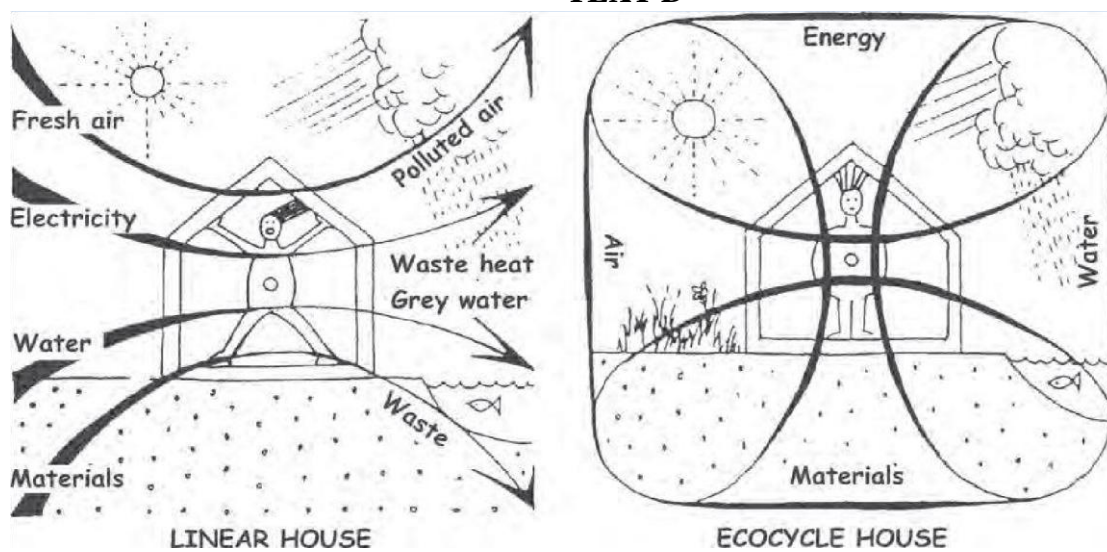

Fig. 44. Types of houses

Exercise 26. Look at the picture. There are two types of houses. Now read the sentences and choose which word best fits each blank. Then discuss the following questions in pairs.

1. Linear / ecocycle

- A. A ... house is a house where large amounts of resources flow through and become problematic waste.
- B. An ... house is a house where the resource requirements are reduced and resources move in a cycle.

2. Compare two pictures:

- Which picture represents environmentally friendly type of a house? Why?
- Which type of a house harms the environment? In what ways?
- Where would you prefer to live? Why?

Exercise 27. Match the pictures with the following words and phrases.

- | | |
|-------------------------|------------------|
| A. Vegetation. | D. Wind power. |
| B. Solar cells. | E. Solar heat. |
| C. Hydroelectric power. | F. Runoff water. |

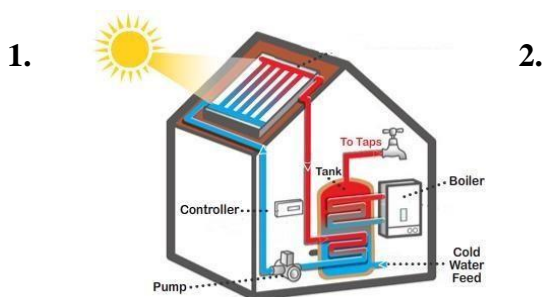

3.



4.



5.



6.



Exercise 28. Match the words with their definitions.

- | | |
|---|---|
| 1. Circulate. | A. Used water that is carried away from houses by pipes under the ground. |
| 2. Nutrients. | B. Very clean, so that bacteria cannot spread |
| C. To move around or through something, or to | 3. Pumps. make something move around or through something. |
| D. Removal of dirty or harmful substances | |
| 4. Integrate. | from something. |
| | E. Chemicals or food that provides what is |
| 5. Sewage. | needed for plants or animals to live and grow. |
| | F. Machines for forcing liquid or gas into or out of something. |
| 6. Purification. | G. To combine two or more things to make something more effective. |
| 7. Hygienic. | |

Exercise 29. Read the text below. Match each part of the text (A–D) with the correct heading (1–4).

1. Sewage Systems that Recycle Nutrients
2. Recirculating Organic Material
3. Heating and Cooling with Renewable Energy Sources
4. Producing Electricity with Renewable Energy Sources

ECOCYCLES

The resources used in a sustainable construction should circulate in an ecological cycle. Energy systems based on renewable energy sources are used. Sewage systems are chosen to recycle nutrients. Organic material is returned to the earth to provide nutrients for vegetation and cultivation.

A. _____

Renewable heat involves using biomass in combination with solar heat. Such systems use an accumulation tank to store heat. Heat pumps are also used. They make use of low-temperature environmental heat to heat and cool.

B. _____

This refers to generating electricity from hydroelectric power. Additional renewable electricity may come from biomass power plants and wind power. In the long run, solar cells will become cheaper and be integrated into roofs and facades.

C. _____

Sorting sewage is a way to minimize pollution. Sewage can be separated into runoff water, traffic water, grey water, urine and black water. Mechanical and chemical purification can be complemented with natural purification methods. It should be easy to return the final products to agriculture in a hygienic manner.

D. _____

Vegetation and cultivation fulfil several functions: they produce food and energy and return organic waste and sewage sludge to ecological cycles. The biological diversity, beauty and well-being they provide are also important. Wild areas, parks and gardens, vegetation around buildings, on buildings and in buildings are important features.

Exercise 30. Answer the questions.

1. What systems are used in a sustainable construction?
2. What does renewable heat involve?
3. What are heat pumps used for?
4. Where may additional renewable electricity come from?
5. Is the application of solar cells common practice?
6. Why is sorting sewage important?
7. What can sewage be separated into?
8. What types of purification do you know?
9. What functions do cultivation and vegetation perform?

Exercise 31. Choose the best answer. More than one option is possible.

1. Nutrients are recycled by ... A.
Heat pumps.
- B. Sewage systems.
- C. Accumulation tank.

2. Renewable heat involves using biomass in combination with solar heat.

A. Yes

B. No

3. Renewable heat ...

A. Returns organic waste to ecocycles.

B. Recycles nutrients.

C. is used for heating and cooling.

4. Electricity is produced by ... A.

Sewage systems.

B. Heat pumps.

C. Hydroelectric power.

5. Solar cells are integrated into ... A.

Roofs.

B. Walls.

C. Facades.

6. Sewage can be divided into ... A.

Runoff water.

B. Solar heat.

C. Grey water.

Exercise 32. Translate the following words and word-combinations. The text above will help you.

1. Возобновляемые источники энергии.

2. Солнечное тепло.

3. Производить электроэнергию.

4. Энергия ветра.

5. Сведение загрязнения к минимуму.

6. Канализация.

7. Самоочищение.

8. Биологическое разнообразие.

Exercise 33. Make up 8 sentences using the words and phrases from the exercise above.

Exercise 34. Fill in the spider diagram below with the details describing the resources of ecocycles.

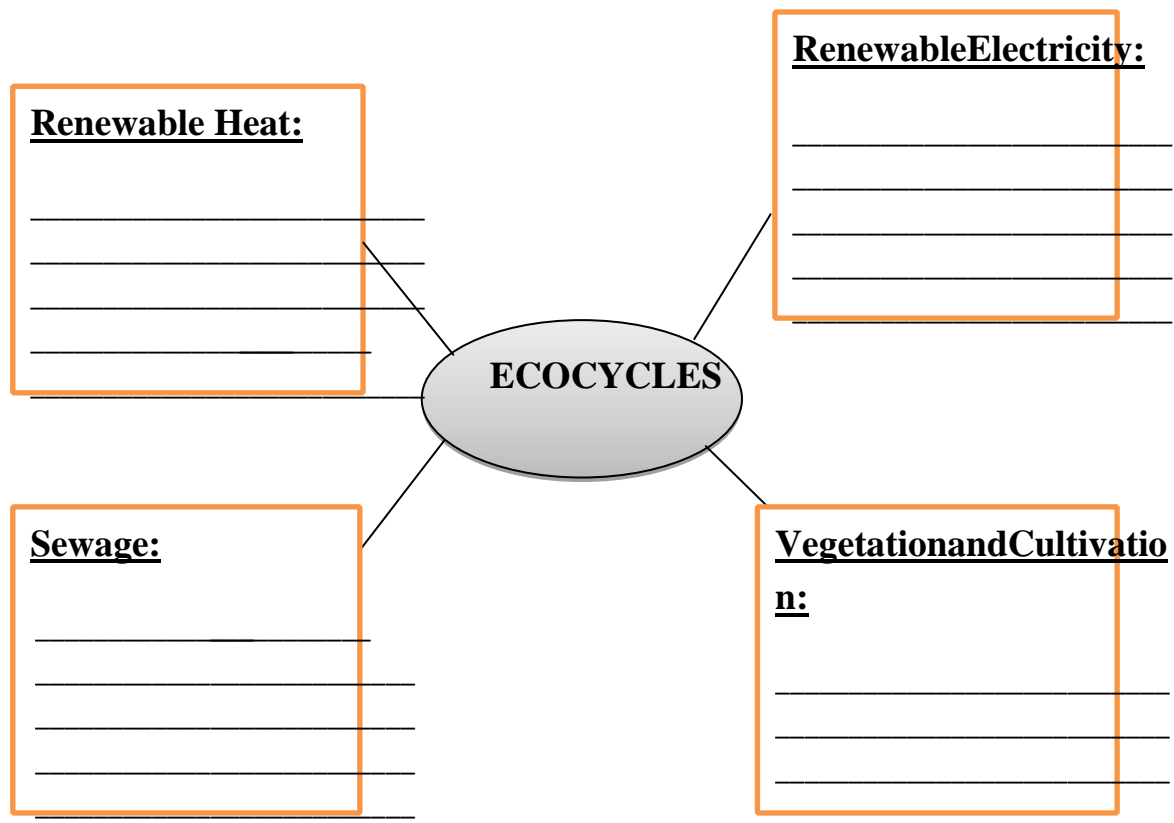

Exercise 35. You are going to watch the video “My Green School Dream”, but first read the information about John Hardy and his project.

After selling his jewelry company in 2007, John Hardy and his wife, Cynthia, endowed a thrilling new project: the Green School in Bali. At the Green School, kids learn in open-air classrooms surrounded by acres of gardens that they tend; they learn to build with bamboo; and meanwhile they're being prepared for traditional British school exams. The school is international –20 percent of students are Bali locals,

some on scholarship. The centerpiece of the campus is the spiraling Heart of School, which may be called Asia's largest bamboo building.

36. Use the information above to answer the following questions.

1. What is the concept of the Green School?
2. Where is this school located?
3. What is it made of?
4. Who studies there?
5. How do you think Hardy's project helps environment?

Fig. 45. Jewelry designer John Hardy co-founded the extraordinary Green School in Bali, where kids get a Holistic and green education.

Exercise



6. In your opinion, is the Green School better for kids comparing to traditional ones?

Exercise 37. Work in pairs. What do you think you will see in the video “My Green School Dream”?

Exercise 38. Watch Video 7.1 and choose the correct answer.
https://www.ted.com/talks/john_hardy_my_green_school_dream

1. Where did the speaker meet his wife?
A. Canada.
B. Bali.
C. The USA.
2. The classrooms don't have ...
A. Doors.
B. A roof.
C. Walls.
3. The classrooms have natural light.
A. Yes.
B. No.
C. Not given.
4. They teach their kids that the world is ...
A. Indestructible.
B. Everlasting.
C. Perishable.
5. People are building green community near the school.
A. Yes.
B. No.
6. What do children do with the tapioca roots?
A. Make chips.
B. Boil.
C. Not given.



Fig.

46. The tapioca roots

7. They cook food using ...
A. Gas.
B. Sawdust burner.
C. Electricity.
8. What is the main building material?
A. Teak.
B. Coconut tree.
C. Bamboo.

Exercise 39. Watch the video segment (1:53– 4:14) and fill in the gaps.

Here it is: it's called the Green School. I know it doesn't look like a school, but it is something we decided to do, and it is extremely, extremely _____. The classrooms have no _____. The teacher is writing on a _____ blackboard. The desks are not square. At Green School, the children are

smiling – an unusual thing for school, especially for me. And we practice _____. Our children spend _____ days going to school in a box. The people that built my school also built the prison and the insane asylum out of the same materials. So if this gentleman had had a holistic education, would he be sitting there? Would he have had more _____ in his life?

The classrooms have _____ light. They're beautiful. They're bamboo. The _____ passes through them. And when the natural breeze isn't enough, the kids deploy bubbles, but not the kind of bubbles you know. These bubbles are made from natural _____ and rubber from the rubber tree. So we basically turned the box into a bubble. And these kids know that _____ climate control may not be part of their future. We pay the bill at the end of the month, but the people that are really going to pay the bill are our grandchildren. We have to teach the kids that the world is not _____. These kids did a little graffiti on their desks, and then they signed up for two extra courses. The first one was called _____ and the second one was called _____. But since that happened, they own those desks. They know they can control their world.

Exercise 40. Prepare 6 questions on the topic and ask your partner. Work in pairs and take turns.

Exercise 41. Imagine you are studying in the Green School in Bali and you are to write a letter to your friend describing your daily routine and learning process. Think of what you like or dislike about the school. Write 18-20 sentences.



Fig. 47. The Green School in Bali *Dear*

Lucy,

Best wishes,

Tom

SUPPLEMENTARY READING

Unit 4. Major Building Systems

FRAMED STRUCTURES

Framed structures are a collection of horizontal beams (forming each floor level) that transmit forces to vertical columns. These columns in turn provide a pathway through which the forces can travel downwards to the foundations and from there into the ground. The vertical columns may form the walls at the perimeter of the building, or they may be distributed throughout the space. When positioned within the space, two or more columns may be joined to create internal divisions, or they may be left as discrete columns.

The great benefit of this multi-level framework is that, because the columns are transmitting the loads vertically, solid-wall structures are not needed to support the floors above, and can therefore be omitted (creating large open spaces), or walls can be created using nonstructural materials such as glass.

Framed structures allow us to build high-rise buildings that are often characterised by facades composed entirely of glass, though the materials used for these curtain walls can be practically anything. Radical architects of the Bauhaus movement in Germany in the 1920s were the first to use of glass in this innovative way. Because of the strength of frames, buildings can be made very tall. It was the development of framed structures in the latter part of the nineteenth century that led to the first high-rise buildings.

Lightweight timber frames are a common method of construction in many regions of the world, though the frame is usually invisible under a skin of other materials such as brick. Frames of this type will usually be braced to prevent twisting by the addition of a plywood skin to the outside of the frame. Timber framing of residential developments allows fast and accurate construction by a relatively low skilled workforce, as it is an easy material to work with. Sections of the frame are often pre-fabricated off site under good working conditions, then brought to the site for rapid assembly.

Timber frames are also an environmentally-friendly construction method. Highly energy-efficient buildings can be made by inserting insulation between the vertical and horizontal timbers creating buildings that perform extremely well in some of the most extreme climates.

LOAD-BEARING STRUCTURES

In a load-bearing structure, it is the masonry construction of the walls themselves that takes the weight of the floors and other walls above. The walls therefore provide the pathways through which forces travel down the structure to the foundations. There is no separate constructional element of the building to do this, as with the frame in a framed structure. Care must be taken when changing existing load-bearing elements of a structure. If changes are made to the structure without adequate precautions, then the structure will collapse.

If it is desired to move a door or window, or make new openings in a wall, then the loads that are being supported by the wall must be diverted to the sides of the opening to prevent collapse. This is usually achieved by the insertion of a beam or lintel at the top of the opening. This lintel will carry the

loads travelling through the wall into the structure at the side of the opening, from where they will travel downwards and so maintain the integrity of the structure. The beam or lintel itself will need to be adequately supported at both ends within the remaining structure.

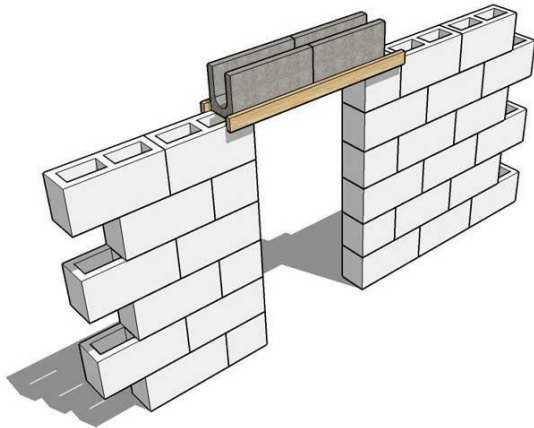

A lintel is a monolithic component and can be manufactured from any suitable material. Timber, stone, concrete (either reinforced or pre-stressed) or steel are the most common. Pre-stressed concrete lintels can span considerable distances, as can rolled steel joists (RSJs), which are often used in renovation work to allow the removal of internal walls.

If greater distances need to be spanned, it may be more appropriate to construct an arch rather than use a lintel, and this was certainly true before new technologies

A. **Lintel** allowed the use of steel and concrete. Because of their

superior mechanical properties, arches can generally support greater loads than lintels. An arch is considered as a single unit, but unlike a lintel it can be composed of a number of components, though it too can be monolithic, like a lintel. Once the individual elements of the arch are in place, the compressive forces (weight) of the building materials above hold them together. The simplest shape of arch is the round or semicircular arch, but there are many variations of form, even flat arches. Arch construction is a very practical engineering solution to the problem of spanning openings that are often treated as decorative elements of a building's facade.

SHEATHING

Sheathing is the board or panel material used in floors, walls and roofs of both residential and commercial construction. The most basic function of sheathing is to form a surface onto which other materials can be applied. There are several types of sheathing, each having a specific function based on its application.

Floor sheathing is a structural panel that is fastened to the floor



B. **Exterior Wall Sheathing**

structure with nails and glue. It is most often installed after a floor frame has been built, and prior to the walls being erected. Commonly called sub-flooring, structural panels are wood products known as plywood and oriented strand board (OSB). Plywood is made from thin sheets of veneer that are adhered together, and OSB is made from wood chips that are adhered together.

Exterior wall sheathing prevents wind and water from entering. There is either non-structural or structural sheathing. Also known as insulating sheathing, non-structural sheathing is installed on an exterior wall to provide added insulation, and in some cases it acts as a radiant barrier. Non-structural sheathing can be applied directly to the exterior wall framing, where diagonal bracing has been installed. It may also be installed on the interior or exterior side of structural sheathing. There are many types of insulating sheathing offering various R-values: plastic, foam, cellulose fiber, paper faced and foil faced boards. Insulating sheathing is a lightweight panel that is easily cut with a knife. The panels are attached with large-headed galvanized nails to exterior wall framing.

Structural sheathing is attached to the exterior wall framing. There are several different types of structural sheathing to choose from; they can be either wood, gypsum or cement based sheathing.

Wood based structural sheathing includes plywood and oriented strand board. Wood sheathing prevents wall racking in wood framed structures.

Gypsum based structural sheathing can be paper-faced, glass-mat faced or unfaced corereinforced sheathing. Paper-faced gypsum and unfaced gypsum/cellulose core-reinforced sheathing are combustible materials and are not moisture resistant. Glass-mat faced gypsum sheathing is noncombustible and moisture resistant.

Cement based structural sheathing can be cement board or fiber cement sheathing. Cement board sheathing is made with Portland cement that is reinforced with glass-fiber mesh. These boards are noncombustible and resist moisture damage. Fiber cement sheathing is also made with Portland cement, but reinforced with cellulose. Fiber cement sheathing is combustible and not moisture resistant. Cement based sheathing is typically used on exterior walls under ceramic tile and thin brick.

Roof sheathing provides lateral bracing of roof framing members, and it carries both live and dead loads from above to the rafters and trusses below. Similar to exterior wall wood sheathing, roof sheathing includes plywood and oriented strand board.

Unit 5. Modern Construction Technologies

TOMORROW" S BUILDINGS

Instead of men in high-visibility jackets and hard hats, there are going to be drones buzzing overhead, robotic bulldozers and 3D printers building new structures.

US start-up Skycatch is using drones on some building projects. The drones give a bird's-eye view of a site and provide progress reports, speed up the logistics by monitoring deliveries and offer updates on any changes to be made to the plans. Japanese construction machinery giant Komatsu has gone one step further – using the Skycatch drones to provide the eyes for C.



Using Drones on Building Projects automated bulldozers. The drones send 3D models of a building site to a computer which then sends the information to unmanned machinery to lay their course.

By 2030 about three billion people will require housing, and 3D printing is one possible solution. It is already making an impact on the construction industry – cutting both the time and cost of building houses.

A team in the School of Civil and Building Engineering at Loughborough University has been working on the technology since 2007, first developing a 3D concrete printer and more recently adapting it to work with a robotic arm. Using a robotic arm means that the team can print up to 10 times faster and create a huge variety of forms, including curved, hollow and geometrically complex shapes.

The team decided to work with concrete as their main material because they believe there are very good reasons why the built world is made mainly out of steel and concrete – including durability, mechanical performance and aesthetic properties.

Prof Austin sees the future of 3D printing as a way of printing key components of buildings rather than whole structures (as in China). "I'm not convinced 3D-printed concrete would be interesting

to the whole housing market. In the developing world labour is cheap and they have developed ways of building homes with local materials that have worked for hundreds of years. So the idea of bringing a printing machine to a site to print whole houses is a little bit unreal," he said. "On the other hand, printing building components of various shapes is an attractive approach that will be realised."

NATURE-INSPIRED DESIGNS

Design studio Emerging Objects has come up with 3D-printed porous bricks called Cool Bricks that can be filled with water to bring down temperatures.

Each 3D-printed cool brick has a 3D ceramic lattice-like structure that can hold water in its pores, like a sponge. When air flows through the porous brick it absorbs evaporated water vapour, becoming cooler in the process.

According to the designers, if all the walls of a house were built with porous, cool bricks, the air flow through them could bring down the home's internal temperature.

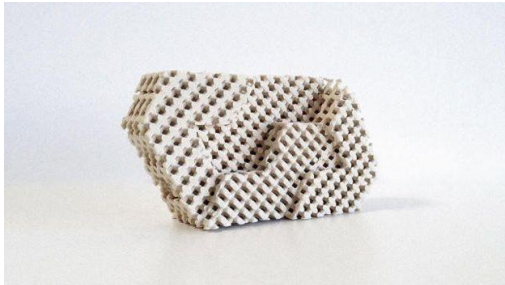

D. 3D Printed Bricks



E. Pine Cone Shape

At the Institute for Computational Design, David Correa is convinced that buildings will only be truly smart when they are built with smart materials – many of which can be found in the natural world. He says, "Pine cones have been working for millions of years, so imagine a roof surface that can open when it is sunny and close when it rains." The team designed just such a structure and is now working on creating new materials that can respond to a variety of environmental conditions.

Allison Dring has designed a smog-eating facade that is coated with a special paint made from titanium dioxide, a pollution-fighting technology that is activated by daylight. It absorbs the fumes generated from traffic and converts them first into nitric acid and then into calcium nitrate, which is harmless.

A facade of this kind has been put on the side of a hospital in Mexico City. It reduces pollution of about 1,000 cars per day. **F. Smog-eating Facade**



HORIZONTAL DIRECTIONAL DRILLING

The horizontal directional drilling (HDD) technique is on the way up at the moment. The application of HDD enables trenchless installations up to 500 m length. Crossings underneath rivers and other waters are frequently performed. The directional method even makes drillings underneath industry complexes possible. The spectrum of application includes heating and drinking water supply,

the installation of pressure lines for sewers as well as cable protection pipes for television or telephone cables.

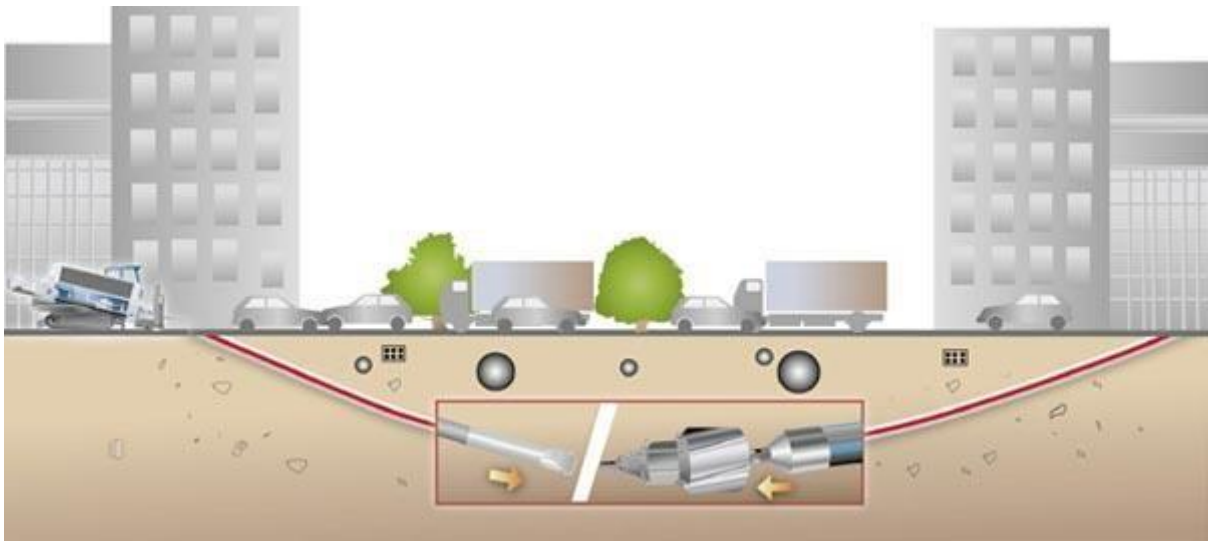

G. The Horizontal Directional Drilling Technique

The HDD method is extremely protective towards the environment, causing no ecological damage at all. Several reasons also speak for the application of the directional technique in central town areas. These mainly concern the construction costs, construction periods, permission procedures, soil movement, surface restoration and the traffic, compared to open trenching methods.

A well planned HDD operation includes preliminary survey of the bore path area, concerning other existing external lines and the soil condition.

The choice of the drilling unit depends upon the bore length, the diameter of the pipe to be installed and the soil quality.

Keeping up a certain bore path is the main problem of the pilot bore, when the fluid assisted technique fails because of mechanical soil resistance. For these conditions, there are the TT drilling facilities with built-in impact unit, which can be switched on when the drilling progress becomes unsatisfactory due to problematic grounds.

Localisation is carried out following the transmitter-receiver principle. One operator follows the course of the bore head all the time. All measured values are taken to protocol, directional corrections are passed on to the machine operator via radiophone. It is also possible to directly store the data found in this way, printing them with the help of a PC or Laptop later on.

On arrival, the drilling head is replaced by an upsizing head. One or more intermediate reaming operations follow, or the pipe is pulled in at once.

Advantages of the HDD method:

- surfaces are neither broken up nor damaged (road surface, front gardens etc.),
- restoration and repair are not required, - short drilling and construction period, - wide spectrum of application.

Unit 6. Safety on Site

CONSTRUCTION HEALTH RISKS: KEY POINTS

There have been big improvements over recent years in reducing the number and rate of injuries to construction workers. Despite this, construction remains a high-risk industry and accounts for a high percentage of fatal and major injuries.

What is less recognised is that construction is a high-risk industry for health issues too. Below are some key points about these risks, why they are so significant and how to manage them.

The big picture.

Every year more working days are lost due to work-related illness compared to injuries. The statistics reveal that construction workers have a high risk of developing diseases from a number of health issues.

- **Cancer** – construction has the largest burden of occupational cancer amongst the industrial sectors. It accounts for over 40% of occupational cancer deaths and cancer registrations. It is estimated that past exposures in the construction sector annually cause over 5,000 occupational cancer cases and approximately 3,700 deaths. The most significant cause of these cancers is asbestos (70%) followed by silica (17%) working as a painter and diesel engine exhaust (6-7% each).
- **Hazardous substances** – dusts, chemicals and potentially harmful mixtures (e.g. in paints) are common in construction work. Some processes emit dusts, fumes, vapours or gases into the air and these can be significant causes of breathing problems and lung diseases. A number of construction –related occupations also have high rates of dermatitis from skin exposures to hazardous substances.
- **Physical health risks** – skilled construction and building trades are one of the occupations with the highest estimated prevalence of back injuries and upper limb disorders. Manual handling is the most commonly reported cause of over seven day injuries in the industry. Construction also has one of the highest rates of ill health caused by noise and vibration.

Underlying causes.

There are many reasons why construction workers have a high risk of developing occupational disease. This includes:

- **The construction site environment** – unlike a factory, construction work takes place in many and varied environments. Different sites can present a range of health risks, including existing ones like asbestos. The extent of these risks can also vary between areas of the same site.
- **The dynamic nature of the work** – construction sites are constantly changing and a large number of trades may all be carrying out tasks potentially dangerous to their health and that of others.
- **Risk appreciation** – there is generally a low awareness of health risks and the controls needed. It can take many years for serious ill health conditions to develop and the immediate consequence of a harmful workplace exposure may often be dismissed as not significant compared to the immediate impact of injuries caused by accidents.
- **Employment** – many workers are either self-employed, work for small companies, or frequently change employers. Others work away from home. These situations can make it problematical for workers to easily look after their own health and they often have little or no contact with occupational health professionals.

Common principles.

The risks of ill health can be managed by following the simple steps. These steps follow a few essential common principles:

- **„Ill-health can be prevented“** – it is possible and practical to carry out construction work without causing ill-health.
- **„Treat health like safety“** – managing health risks is no different to managing safety risks.
- **„Everyone has a role to play“** – everyone involved in construction has a responsibility in managing risks to health. Each must take ownership of their part of the process.
- **„Control the risk, not the symptoms“** – monitoring and health surveillance programmes are not enough on their own. While they are an effective part of managing health risks, the first priority is to stop people being exposed to the risk in the first place.
- **„Manage risk, not lifestyles“** – the law requires steps to be taken to prevent or adequately control work-related health risks. Helping workers tackle lifestyle issues like smoking or diet may be beneficial but is not a substitute for this.

Unit7. Sustainable Construction

UNDERSTANDING SUSTAINABLE CONSTRUCTION

Defining sustainable construction

For most companies, countries and individuals who do take the subject seriously the concept of sustainability embraces the preservation of the environment as well as critical development-related issues such as the efficient use of resources, continual social progress, stable economic growth, and the eradication of poverty.

In the world of construction, buildings have the capacity to make a major contribution to a more sustainable future for our planet. The Organisation for Economic Co-operation and Development, for instance, estimates that buildings in developed countries account for more than forty percent of energy consumption over their lifetime (incorporating raw material production, construction, operation, maintenance and decommissioning). Add to this the fact that for the first time in human history over half of the world's population now lives in urban environments and it's clear that sustainable buildings have become vital cornerstones for securing long-term environmental, economic and social viability.

The pace of change means we don't have the luxury of time. With urban populations worldwide swelling by around one million people every week, there's an urgent need to come up with clever ideas that optimize the sustainable performance of the buildings that we live and work in.

Building a sustainable future

Sustainable construction aims to meet present day needs for housing, working environments and infrastructure without compromising the ability of future generations to meet their own needs in times to come. It incorporates elements of economic efficiency, environmental performance and social responsibility – and contributes to the greatest extent when architectural quality, technical innovation and transferability are included.

Sustainable construction involves issues such as the design and management of buildings; materials performance; construction technology and processes; energy and resource efficiency in building, operation and maintenance; robust products and technologies; long-term monitoring; adherence to ethical standards; socially-viable environments; stakeholder participation; occupational health and safety and working conditions; innovative financing models; improvement to existing contextual conditions; interdependencies of landscape, infrastructure, urban fabric and architecture;

flexibility in building use, function and change; and the dissemination of knowledge in related academic, technical and social contexts.

“TARGET ISSUES” FOR SUSTAINABLE CONSTRUCTION

Innovation and transferability – Progress

Projects must demonstrate innovative approaches to sustainable development, pushing the envelope of practice and exploring new disciplinary frontiers. Breakthroughs and trend-setting discoveries must be transferable to a range of other applications.

- Innovative concepts regarding design, integration of materials and methods, structure, enclosure and mechanical systems.
- Outstanding contributions to construction technologies and building processes, operation and maintenance.
- Advancements in the disciplines of architecture, urban and landscape design, civil, urban and environmental



engineering, and other fields involved in the production of the built environment.

H. High-efficiency concrete formwork technology

- Long-term monitoring methods to evaluate whether expectations and goals have been met.
- Dissemination of knowledge, including project documentation, communication, education and training.

Ethical standards and social inclusion – People

Projects must adhere to the highest ethical standards and promote social inclusion at all stages of construction, from planning and building to use and servicing; to ensure an enduring positive impact on communities. Proposals must demonstrate how they enhance the collective realm.



I. The buildings are cooled by a specially developed natural cooling system through the walls, ceilings and roof structures (Secondary school with passive ventilation system, Gando, Burkina Faso).

- Adherence to ethical standards in all phases of the project.

- Contributions to the formation of socially-viable environments, strengthening of shared values and empowerment of communities.
- Participation of stakeholders, including users, clients, neighborhood affiliations, local authorities and non-governmental organizations.
- Quality of working conditions in the construction industry and including on site; with specific attention given to fair compensation, adequate benefits, safety and gender equality.
- Political transparency, unbiased processes and commitment to principled interaction, just practices, all in the effort to prevent corruption at every level.

Resource and environmental performance – Planet

Projects must exhibit a sensible use and management of natural resources throughout their entire life cycle. Long-term environmental concerns, especially pertaining to stocks and flows of material and energy, should be an integral part of the design philosophy.

- Minimizing a project's ecological footprint and maximizing its positive impact on the environment; reduction of harm and increase of beneficial effects.
- Environmentally-conscious land use strategies and policies that preserve the natural landscape, while taking water and land reclamation into account.
- Emphasis placed on the use of renewable energy in construction, use and upkeep of the built fabric to reduce CO2 emissions and avoid toxicity.



J. Living with Lakes Center for freshwater restoration and research, Sudbury, ON, Canada

- Innovative deployment of material resources in construction with an emphasis on cradle to cradle cycles, mining existing building stocks and reduction of waste.
- Resilient products, robust construction details, smart interaction of building systems and environmentally sound technologies.

Economic viability and compatibility – Prosperity

Projects must prove to be economically feasible with regard to channeling and managing financial flows, promoting an economy of means and be compatible with demands across the construction's lifespan.

- Integration of the project into larger economic frameworks of local, regional, and global monetary flows that show a positive impact of the economy on society and the environment.
- Funding sources and profits earned must be legitimate and transparent.
- Projects must be affordable and operating costs over a structure's lifetime determined in reference to returns on investment.



- Flexibility to adapt to future changes of user needs, ownership, laws, regulations, and economic fluctuations. **K. Urban integration of an informal**
- Innovative economic models are sought that take external area costs into consideration.

Contextual and aesthetic impact – Place

Projects must convey a high standard of architectural quality as a prevalent form of cultural expression. With space, form and aesthetic impact of utmost significance, the material manifestation of the design must make a positive and lasting contribution to the physical, human and cultural environment.

- Improvement of existing contextual conditions responding to the natural and built environment.
- Interdependencies of landscape, infrastructure, urban fabric and architecture.
- Working with the given building stock through sensitive restoration, re-use or re-modeling of the built environment.
- Inventive programming strategies in terms of use, multiplicity of functions, short-term flexibility and long-term adaptability.
- Architectural quality and aesthetic impact, specifically concerning space, spatial sequences, movement, tactility of materials, light and ambiance.



REFERENCES

1. 3D Printing in Construction [Electronic resource] // Designing Buildings Ltd. – Electronic data. – [S. l.], 2016. – URL: http://www.designingbuildings.co.uk/wiki/3d_printing_in_construction
2. Anker, P. From Bauhaus to Ecohouse: a History of Ecological Design / P. Anker. – The USA: LouisianaStateUniversity Press, 2010. –188 p.
3. Armstrong, R. Architecture that Repairs Itself? [Electronic resource] // TED Conferences, LLC. – Electronic data. – New York, 2009. – URL: https://www.ted.com/talks/rachel_armstrong_architecture_that_repairs_itself
4. Baden–Powell, C. Architect“ s pocket book – 2nd ed. / C. Baden–Powell. – UK: Elsevier Science Ltd, 2001. – 305 p.
5. Barry, R. The Construction of Buildings / R. Barry. – UK: Blackwell Science, 1999. – 277 p.
6. Bauer, M. Green Building – Guidebook for Sustainable Architecture / M. Bauer, P. Mösle, M. Schwarz. – Berlin: Springer, 2010. – 209 p.
7. Berge, B. The Ecology of Building Materials / B. Berge. – UK: Architectural Press, 2001. – 453 p.
8. Binggeli, C. Building systems for interior designers / C. Binggeli. – New Jersey: John Wiley & Sons, Inc., 2003. – 452 p.
9. Bokalders, V. The WholeBuilding Handbook: How to Design Healthy, Efficient, and Sustainable Buildings / VarisBokalders and Maria Block. — 1st ed. –London: Earthscan, 2010. – 690 p.
10. Bonamy, D. Technical English – 2 / David Bonamy. – England: Pearson Education Limited, 2008. – 127 p.
11. Building Materials in Modern World: учебноепособие / Сост.:Н.П. Белозерова, Ю.В. Лопухова, Л.В. Федотова; Самарск. гос. арх.-строит. ун-т. Самара, 2007. – 108 с.
12. Caruzzo, P. Flash on English for Construction / P. Caruzzo. – Italy: ESP series, 2012. – 47 p.
13. Chudley, R. Building Construction Handbook. Sixth Edition / R. Chudley, R. Greeno. – UK: Butterworth–Heinemann, 2006. – 728 p.
14. Construction Health and Safety Manual. – 3rd ed. – Canada: Construction Safety Association of Ontario, 2009. – 309p.
15. Construction Week Online [Electronic resource] // ITP Business Publishing Ltd. – Electronic data. – [S. l.], 2016. – URL: <http://www.constructionweekonline.com>
16. Design Dictionary. Perspectives on Design Terminology / ed. By M. Erlhoff, T. Marshall. – Switzerland: Birkhäuser Verlag AG, 2008. – 465 p.
17. Dodsworth, S. Fundamentals of Interior Design / S. Dodsworth. – Switzerland: AVA Publishing SA, 2009. – 184 p.
18. Dudeney, G. How to ... Teach English with Technology / G. Dudeney, N. Hockly. – England: Pearson Education Limited, 2007. – 192 p.
19. EnglishforEngineers: Методические указания по английскому языку. Часть 2 / сост. Э.П. Хафиятуллина, О.К. Гергенредер. – Самара, СГАСУ, 2007. – 43 с.
20. EnglishGrammarinModules: учебное пособие по основам практической грамматики / Сост. Н.П. Белозерова, Ю.В. Лопухова, Л.В. Федотова. – Самара, СГАСУ, 2008. – 224 с.
21. Evans, V. Construction I Buildings / V. Evans, J. Dooley, J. Revels. – Newbury: Express Publishing, 2012. – 120 p.
22. Excavation for foundation [Electronic resource]// The Construction Civil Engineering Home. – Electronic data. - URL:<http://http://theconstructor.org/geotechnical/excavation-for-foundation/5613/>
23. Frendo, E. English for Construction: Part 1, 2. / E. Frendo. – UK: Pearson Education Limited, 2012. – 79 p.
24. Global Construction [Electronic resource] // Construction Global. – Electronic data. – [S. l.], 2016. – URL: <http://www.constructionglobal.com/equipmentit/219/Future-Construction-Technologies-and-Techniques>
25. Green, M. Why We Should Build Wooden Skyscrapers [Electronic resource] // TED Conferences, LLC. – Electronic data. – New York, 2013. – URL: https://www.ted.com/talks/michael_green_why_we_should_build_wooden_skyscrapers
26. Hardy, J. My Green School Dream [Electronic resource] // TED Conferences, LLC. – Electronic data. – New York, 2010. – URL: https://www.ted.com/talks/john_hardy_my_green_school_dream

27. Health and Safety Advice for Construction Operatives. – Northern Ireland: CITB Construction Skills, 2009. – 56 p.
28. Horizontal Directional Drilling Construction [Electronic resource] // Nodig Construction. – Electronic data. – [S. 1.], 2016. – URL: https://www.nodig-construction.com/index.cfm?cmd=techniques&object_id=13
29. How 3D Printing will Revolutionize your Industry [Electronic resource] // Sculpteo. – Electronic data. – [S. 1.], 2014. – URL: <https://www.sculpteo.com/blog/2015/10/07/3d-printing-construction/>
30. Ibbotson, Mark. Cambridge English for Engineering / Mark Ibbotson. – UK: Cambridge University Press, 2008. – 112 p.
31. Ibbotson, Mark. Professional English in Use / Mark Ibbotson. – UK: Cambridge University Press, 2011. – 144 p.
32. Interior Design. Handbook of Professional Practice / ed. by Cindy Coleman. – London: McGraw-Hill, 2002. – 783 p.
33. Kumar S. Building construction. – Delhi: Standard, 1988. – 125 p.
34. Lawson, B. What Designers know / B. Lawson. – UK: Architectural Press, 2004. – 127 p.
35. Lidwell, W. Universal Principles of Design / W. Lidwell, K. Holden, J. Butler. – The USA: Rockport Publishers, 2010 – 272 p.
36. Makhoul, A. The Winchester Guide to Keywords and Concepts for International Students in Art, Media and Design / A. Makhoul and S. Morley. – UK: John Wiley & Sons, Inc, 2015. – 255 p.
37. Merriam Webster Learner's Dictionary [Electronic resource] // Merriam-Webster, Inc. – Electronic data. – [S. 1.], 2016. – URL: <http://www.learnersdictionary.com>
38. Merritt, F.S. Building Design and Construction Handbook / F.S. Merritt, J.T. Ricketts. – New York: McGRAWHILL, 2001. – 1600 p.
39. Minke, G. Building with Earth: Design and Technology of a Sustainable Architecture / G. Minke. – Switzerland: Birkhäuser – Publishers for Architecture, 2006. – 199 p.
40. New TED Book Envisions the „Living“ Cities of the Future [Electronic resource] // TED Conferences, LLC. – Electronic data. – New York, 2012. – URL: <http://blog.ted.com/new-ted-book-envisions-the-living-cities-of-the-future/>
41. Oxford Dictionaries: Language Matters [Electronic resource] // Oxford University Press. – Electronic data. – [S. 1.], 2016. – URL: www.oxforddictionaries.com/
42. Poulin, R. Graphic design and architecture, a 20th century history: a guide to type, image, symbol, and visual storytelling in the modern world / R. Pulin. – The USA: Rockport Publishers, 2012. – 272 p.
43. Schittich, C. Solar Architecture / C. Schittich. – Switzerland: Birkhäuser – Publishers for Architecture, 2003. – 176 p.
44. Sebestyen, G. New Architecture and Technology / G. Sebestyen, C. Pollington. – UK: Architectural Press, 2003. – 178 p.
45. Sheathing [Electronic resource] // Buildipedia.com, LLC. – Electronic data. – [S. 1.], 2016. – URL: <http://buildipedia.com/knowledgebase/division-06-wood-plastics-and-composites/06-10-00-rough-carpentry/0616-00-sheathing/06-16-00-sheathing>
46. Thornbury, S. How to Teach Speaking / S. Thornbury. – England: Pearson – Longman, 2005. – 156 p.
47. Thornbury, S. How to Teach Vocabulary / S. Thornbury. – England: Pearson Education Limited, 2002. – 185 p.
48. Top Ten Construction Innovations [Electronic resource] // Raconteur Media Ltd. – Electronic data. – London, 2016. – URL: http://www.designingbuildings.co.uk/wiki/3d_printing_in_construction
49. Training required for construction work [Electronic resource] // Construction and steel exhibition. – Electronic data. – URL: <http://brighthubengineering.com>
50. Wakefield, J. Tomorrow's Buildings: Construction industry goes robotic [Electronic resource] // BBC. – Electronic data. – [S. 1.], 2016. – URL: <http://www.bbc.com/news/technology-35746648>